

Neosys Technology Inc.

MezIO™ Module

Installation Guide

Revision 1.1

Table of Contents

Table of Contents	2
Legal Information	4
Contact Information	5
Copyright Notice	6
Safety Precautions	7
Service and Maintenance	8
ESD Precautions	8
About This Guide	9

1 Introduction

1.1 Overview: MeziO™ Interface	10
1.2 POC & Nuvo-5000 Series MeziO™ Module Compatibility Table	11
1.3 Nuvo-7000 Series MeziO™ Module Compatibility Table	12
1.4 MeziO™ Module Overview	13
1.4.1 8-port RS-232/ 422/ 485	13
1.4.2 16-mode Ignition Power Control	13
1.4.3 32/16-CH Isolated Digital I/O	14
1.4.4 SATA port for 2.5" HDD/SSD	14
1.4.5 4x PoE+ ports	15
1.4.6 4x GigE ports	15
1.4.7 4x USB 3.0 ports	15

2 MeziO™ Module Specifications

2.1 MeziO™ C180/ MeziO™ C181	16
2.1.1 Specification of MeziO™ C180	16
2.1.2 Specification of MeziO™ C181	16
2.1.3 SCSI 68 Pin-out	17
2.1.4 Device Connector Pin-out	19
2.2 MeziO™ D220/ MeziO™ D230	20
2.2.1 Specification of MeziO™ D230	20
2.2.2 Specification of MeziO™ D220	21
2.2.3 Wiring for Isolated DIO	22
2.2.4 MeziO™ D230 Pin-out	23
2.2.5 Pin-out of MeziO™ D220	24
2.2.6 DIO Function Reference	24
2.3 MeziO™ V20 (Nuvo-5000LP/ POC-300 Only)	28
2.3.1 Specification of MeziO™ V20	28
2.3.2 Internal I/O function	28
2.3.3 Principle of Ignition Power Control	30
2.3.4 Ignition Signal Wiring	32
2.3.5 Operation Modes of Ignition Power Control	33
2.3.6 Configure Your Windows System	35
2.4 MeziO™ R10 (POC-120MZ Only)	36
2.4.1 Specification of MeziO™ R10 (Nuvo-5000LP Only)	36
2.4.2 Internal I/O Functions	36
2.5 MeziO™-G4P/ G4	38
2.5.1 Specification of MeziO-G4P	38
2.5.2 Specification of MeziO-G4	38
2.6 MeziO™-U4-30/ 50	38
2.6.1 Specification of MeziO™-U4-30	38
2.6.2 Specification of MeziO™-U4-50	38

3 MeziO™ Module Installation

3.1 POC-120MZ MeziO™ Installation/ Replacement	40
3.2 POC-300 MeziO™ Installation/ Replacement	43

3.3	Nuvo-5000 Series Disassembly Procedure	46
3.3.1	Nuvo-5000E/P Series	46
3.3.2	Nuvo-5000LP Series	48
3.3.3	Nuvo-5095GC Series.....	49
3.3.4	Nuvo-5000 Series MezIO™ Module Installation	50
3.4	Nuvo-7000 Series Disassembly Procedure	51
3.4.1	Nuvo-7000E/ P/ DE/ LP	51
3.4.2	Nuvo-7000E/ P/ DE/ LP MezIO™ Module Installation.....	58
3.5	Nuvo-7160GC Series Disassembly Procedure.....	65
3.5.1	Nuvo-7160GC.....	65
3.5.2	Nuvo-7160GC MezIO™ Installation.....	69

4 Driver Installation

4.6	MezIO™ C180/ C181 Driver Installation	75
4.7	MezIOTM D220/ D230 Driver Installation	83

Legal Information

All Neosys Technology Inc. products shall be subject to the latest Standard Warranty Policy

Neosys Technology Inc. may modify, update or upgrade the software, firmware or any accompanying user documentation without any prior notice. Neosys Technology Inc. will provide access to these new software, firmware or documentation releases from download sections of our website or through our service partners.

Before installing any software, applications or components provided by a third party, customer should ensure that they are compatible and interoperable with Neosys Technology Inc. product by checking in advance with Neosys Technology Inc.. Customer is solely responsible for ensuring the compatibility and interoperability of the third party's products. Customer is further solely responsible for ensuring its systems, software, and data are adequately backed up as a precaution against possible failures, alternation, or loss.

For questions in regards to hardware/ software compatibility, customers should contact Neosys Technology Inc. sales representative or technical support.

To the extent permitted by applicable laws, Neosys Technology Inc. shall NOT be responsible for any interoperability or compatibility issues that may arise when (1) products, software, or options not certified and supported; (2) configurations not certified and supported are used; (3) parts intended for one system is installed in another system of different make or model.

Contact Information

Headquarters
(Taipei, Taiwan)

Neosys Technology Inc.

15F, No.868-3, Zhongzheng Rd., Zhonghe Dist., New Taipei City, 23586, Taiwan

Tel: +886-2-2223-6182 Fax: +886-2-2223-6183 [Email](#), [Website](#)

Americas
(Illinois, USA)

Neosys Technology America Inc.

3384 Commercial Avenue, Northbrook, IL 60062, USA

Tel: +1-847-656-3298 [Email](#), [Website](#)

China

Neosys Technology (China) Ltd.

Room 612, Building 32, Guiping Road 680, Shanghai

Tel: +86-2161155366 [Email](#), [Website](#)

Copyright Notice

All rights reserved. This publication may not be reproduced, transmitted, transcribed, stored in a retrieval system, or translated into any language or computer language, in any form or by any means, electronic, mechanical, magnetic, optical, chemical, manual or otherwise, without the prior written consent of Neosys Technology, Inc.

Disclaimer

This manual is intended to be used as an informative guide only and is subject to change without prior notice. It does not represent commitment from Neosys Technology Inc. Neosys Technology Inc. shall not be liable for any direct, indirect, special, incidental, or consequential damages arising from the use of the product or documentation, nor for any infringement on third party rights.

Patents and Trademarks

Neosys, the Neosys logo, Expansion Cassette, MezIO™ are registered patents and trademarks of Neosys Technology, Inc.

- Windows is a registered trademark of Microsoft Corporation.
- Intel®, Core™ are registered trademarks of Intel Corporation
- NVIDIA®, GeForce® are registered trademarks of NVIDIA Corporation

All other names, brands, products or services are trademarks or registered trademarks of their respective owners.

Safety Precautions

Read these instructions carefully before you install, operate, or transport the system.

- Install the system or DIN rail associated with, at a sturdy location
- Install the power socket outlet near the system where it is easily accessible
- Secure each system module(s) using its retaining screws
- Place power cords and other connection cables away from foot traffic. Do not place items over power cords and make sure they do not rest against data cables
- Shutdown, disconnect all cables from the system and ground yourself before touching internal modules
- Ensure that the correct power range is being used before powering the device
- Should a module fail, arrange for a replacement as soon as possible to minimize down-time
- If the system is not going to be used for a long time, disconnect it from mains (power socket) to avoid transient over-voltage

Service and Maintenance

- ONLY qualified personnel should service the system
- Shutdown the system, disconnect the power cord and all other connections before servicing the system
- When replacing/ installing additional components (expansion card, memory module, etc.), insert them as gently as possible while assuring proper connector engagement

ESD Precautions

- Handle add-on module, motherboard by their retention screws or the module's frame/ heat sink. Avoid touching the PCB circuit board or add-on module connector pins
- Use a grounded wrist strap and an anti-static work pad to discharge static electricity when installing or maintaining the system
- Avoid dust, debris, carpets, plastic, vinyl and styrofoam in your work area.
- Do not remove any module or component from its anti-static bag before installation

About This Guide

This guide introduces the MezIO™ module and lists compatible systems. The guide also demonstrates how to disassemble the necessary system panel(s) for MezIO™ module installation.

Revision History

Version	Date	Description
1.0	Jun. 2019	Initial release
1.1	Sep. 2021	Updated SCSI-68 PIN 4 pintout definition and MezIO™ D230/ D220 Logic Low Voltage range

1 Introduction

1.1 Overview: MezIO™ Interface

MezIO™ is an innovative interface designed for integrating application-oriented I/O functions into an embedded system. It offers power rails, computer and control signals via a high-speed connector for the MezIO™ module to leverage vital signals to implement comprehensive I/O functions.

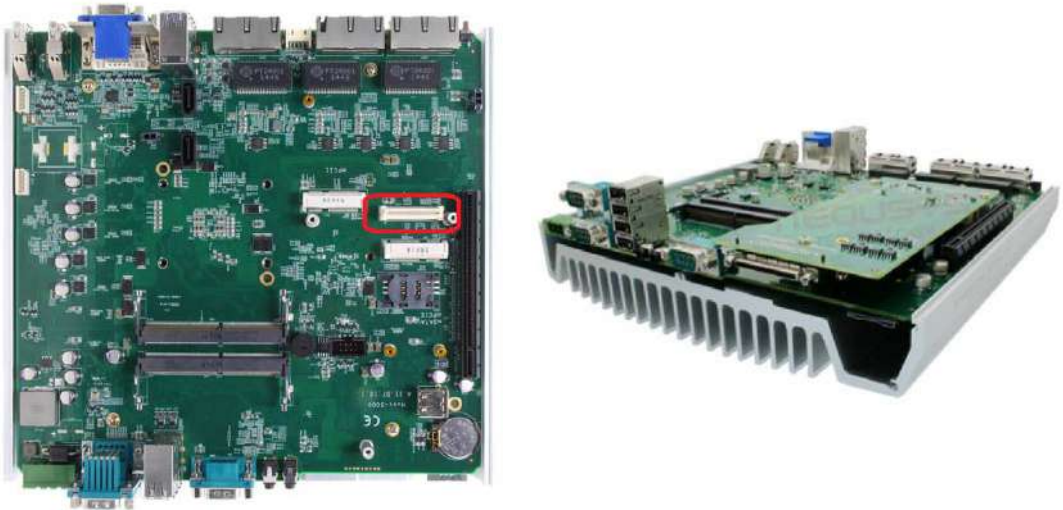

Neosys has various systems that are compatible with and incorporates the MezIO™ easy-to-install design to accommodate Neosys' MezIO™ modules. For customers who want to customize their own MezIO™ module, Neosys provides MezIO™ design documents on a NDA basis. Please contact Neosys for further information.

1.2 POC & Nuvo-5000 Series MezIO™ Module

Compatibility Table

	POC-120MZ	POC-300	Nuvo-5000LP	Nuvo-5000E/P	Nuvo-5095GC Nuvo-5026E
8-port RS-232/422/485					
MezIO-C180-50		V	V	V	V
MezIO-C180-12	V				
MezIO-C181-50		V	V	V	V
MezIO-C181-12	V				
16-mode Ignition Power Control					
MezIO-V20		V	V		
MezIO-V20-EP				V	V
32/16-CH Isolated Digital I/O					
MezIO-D230-50		V *	V	V	V
MezIO-D230-12	V				
MezIO-D220-50		V *	V	V	V
MezIO-D220-12	V				
SATA port for 2.5" HDD/SSD					
MezIO-R10	V				
MezIO-R11		V			
MezIO-R12		V			
PoE+ ports					
MezIO-G4P			V**	V**	V**
GigE ports					
MezIO-G4			V	V	V
USB 3.0 ports					
MezIO-U4-30		V			
MezIO-U4-50			V	V	V

Legend

Dedicated panel	Existing panel I/O opening	Not applicable
-----------------	----------------------------	----------------

 **NOTE**

* When using MezIO-D220-50 or MezIO-D230-50 on POC-300 series, the mini-PCIe socket on board can't be used because of mechanical interference.

**When using MezIO-G4P on Nuvo-5000 series systems, please make sure your system has PoE function. Please contact your sales vendor if you are unsure.

1.3 Nuvo-7000 Series MezIO™ Module Compatibility

Table

	Nuvo-7000LP	Nuvo-7000E/P	Nuvo-7000DE	Nuvo-7160GC
8-port RS-232/422/485				
MezIO-C180-50	V	V	V	V
MezIO-C181-50	V	V	V	V
16-mode Ignition Power Control				
MezIO-V20	V			
MezIO-V20-EP		V	V	V
32/16-CH Isolated Digital I/O				
MezIO-D230-50	V	V	V	V
MezIO-D220-50	V	V	V	V
PoE+ ports				
MezIO-G4P	V	V	V	V
GigE ports				
MezIO-G4	V	V	V	V
USB 3.0 ports				
MezIO-U4-50	V	V	V	V

Legend

Dedicated panel	Existing panel I/O	Not applicable
-----------------	--------------------	----------------



NOTE

When using MezIO-G4P on Nuvo-7000 series systems, please make sure your system has PoE function. Please contact your sales vendor if you are unsure.

1.4 MezIO™ Module Overview

Neosys offers MezIO™ modules to expand I/O functions for various Neosys systems. With the addition of a MezIO™ module into your Neosys controller, it offers extra RS-232/422/485 ports, isolated digital I/O or ignition power control. For future expandability and practicality, Neosys will continue to develop MezIO™ modules with versatile features for your Neosys embedded products.

1.4.1 8-port RS-232/ 422/ 485

Model	Description
MezIO-C180-50	For Nuvo-5000 series / POC-300 Series <ul style="list-style-type: none"> ● 4 x RS-232 ports ● 4 x RS-232/422/485 ports
MezIO-C180-12	For POC-120MZ <ul style="list-style-type: none"> ● 4 x RS-232 ports ● 4 x RS-232/422/485 ports
MezIO-C181-50	For Nuvo-5000 series / POC-300 Series <ul style="list-style-type: none"> ● 4 x RS-422/485 ports ● 4 x RS-232/422/485 ports
MezIO-C181-12	For POC-120MZ <ul style="list-style-type: none"> ● 4 x RS-422/485 ports ● 4 x RS-232/422/485 ports
Cable-S68MD9M-50	<ul style="list-style-type: none"> ● SCSI-68(M) to 8x DB-9(M) cable, 50 cm

1.4.2 16-mode Ignition Power Control

Model	Description
MezIO-V20	For POC-300 Series / Nuvo-5000LP <ul style="list-style-type: none"> ● 16-mode ignition power control for in-vehicle usage ● 1x mini-PCIe socket with SIM socket
MezIO-V20-EP	For Nuvo-5095GC / Nuvo-5000E/P <ul style="list-style-type: none"> ● Ignition power control function for in-vehicle usage
MezIO-V30 (not for sale)	For POC-351VTC <ul style="list-style-type: none"> ● Ignition power control function for in-vehicle usage ● 1x CAN 2.0 port ● 4-CH isolated DI and 4-CH isolated DO ● 1x full-size mSATA port (SATA only) ● 2x full-size mini-PCIe socket (PCIe + USB) with SIM socket ● 1x M.2 Socket (USB 2.0 only) with SIM socket

1.4.3 32/16-CH Isolated Digital I/O

Model	Description
MezIO-D230-50	For Nuvo-5000 series / POC-300 Series <ul style="list-style-type: none"> ● 16-CH isolated DI ● 16-CH isolated DO
MezIO-D230-12	For POC-120MZ <ul style="list-style-type: none"> ● 16-CH isolated DI ● 16-CH isolated DO
MezIO-D220-50	For Nuvo-5000 series / POC-300 Series <ul style="list-style-type: none"> ● 8-CH isolated DI ● 8-CH isolated DO
MezIO-D220-12	For POC-120MZ <ul style="list-style-type: none"> ● 8-CH isolated DI ● 8-CH isolated DO
Cable-S68MM-100	<ul style="list-style-type: none"> ● SCSI-68(M) to SCSI-68(M) cable, 100 cm
TB-10	<ul style="list-style-type: none"> ● Terminal board with 68-pin SCSI-II female connector and 68-pole terminal block

1.4.4 SATA port for 2.5" HDD/SSD

Model	Description
MezIO-R10	For POC-120MZ <ul style="list-style-type: none"> ● 1x 2.5" SATA HDD/SSD ● 1x mini-PCIe socket with SIM socket
MezIO-R11	For POC-300 series <ul style="list-style-type: none"> ● 1x 2.5" SATA HDD/SSD
MezIO-R12	For POC-300 series <ul style="list-style-type: none"> ● 1x 2.5" SATA HDD/SSD ● 4-CH isolated DI ● 4-CH isolated DO

1.4.5 4x PoE+ ports

Model	Description
MezIO-G4P	For Nuvo-5000-PoE series <ul style="list-style-type: none">● 4x PoE+ ports, 4x GigE ports by 4x Intel® I210 controllers, supporting 9.5 kB jumbo frame

1.4.6 4x GigE ports

Model	Description
MezIO-G4	For Nuvo-5000 series <ul style="list-style-type: none">● 4x GigE ports by 4x Intel® I210 controllers, supporting 9.5 kB jumbo frame

1.4.7 4x USB 3.0 ports

Model	Description
MezIO-U4-30	For POC-300 series 4x USB3.0 ports (2 pair, 2 ports shared from 1x PCIe x1)
MezIO-U4-50	For Nuvo-5000/ Nuvo-7000 series 4x USB3.0 ports (each port shared from 1x PCIe x1)

2 MezIO™ Module Specifications

2.1 MezIO™ C180/ MezIO™ C181

2.1.1 Specification of MezIO™ C180

# of Port	4x RS-232/ 422/ 485 4x RS-232
Baud Rate	50 bps to 921600 bps
FIFO	256-byte TX and RX FIFOs
ESD Protection	15Kv
Interface Signals	RS-232: TxD, RxD, RTS, CTS, DTR, DSR, DCD, GND RS-422: TxD+, TxD-, RxD+, RxD-, GND RS-485: Data+, Data-, GND
Connector	68-pin SCSI-II female connector
OS Support	Windows 7/ 8/ 8.1/ 10 and Linux kernel 2.6.32 or later

2.1.2 Specification of MezIO™ C181

# of Port	4x RS-232/ 422/ 485 4x RS-422/ 485
Baud Rate	50 bps to 921600 bps
FIFO	256-byte TX and RX FIFOs
ESD Protection	15Kv
Interface Signals	RS-232: TxD, RxD, RTS, CTS, DTR, DSR, DCD, GND RS-422: TxD+, TxD-, RxD+, RxD-, GND RS-485: Data+, Data-, GND
Connector	68-pin SCSI-II female connector
OS Support	Windows 7/ 8/ 8.1/ 10 and Linux kernel 2.6.32 or later

2.1.3 SCSI 68 Pin-out

Please refer to the following SCSI 68 pin-out for corresponding MezIO™ board.



Signal	MezIO™ C180	MezIO™ C181
UART0	RS-232/422/485	RS-232/422/485
UART1	RS-232/422/485	RS-232/422/485
UART2	RS-232/422/485	RS-232/422/485
UART3	RS-232/422/485	RS-232/422/485
UART4	RS-232	RS-422/485
UART5	RS-232	RS-422/485
UART6	RS-232	RS-422/485
UART7	RS-232	RS-422/485

Board Side: RS232 Pin-out of SCSI 68											
Pin	Signal	Pin	Signal	Pin	Signal	Pin	Signal	Pin	Signal	Pin	Signal
1	RxD6	13	DCD4	25	TxD2	37	RI7	49	RI5	61	TxD1
2	CTS6	14	RTS4	26	GND	38	RTS7	50	CTS5	62	DSR1
3	RI6	15	RI4	27	TxD0	39	DCD7	51	RxD5	63	DTR1
4	RTS6	16	CTS4	28	DSR0	40	DTR7	52	RxD3	64	DCD1
5	DCD6	17	RxD4	29	DTR0	41	DSR7	53	CTS3	65	RTS1
6	DTR6	18	RxD2	30	DCD0	42	TxD7	54	RI3	66	RI1
7	DSR6	19	CTS2	31	RTS0	43	GND	55	RTS3	67	CTS1
8	TxD6	20	RI2	32	RI0	44	TxD5	56	DCD3	68	RxD1
9	GND	21	RTS2	33	CTS0	45	DSR5	57	DTR3		
10	TxD4	22	DCD2	34	RxD0	46	DTR5	58	DSR3		
11	DSR4	23	DTR2		RxD7	47	DCD5	59	TxD3		
12	DTR4	24	DSR2		CTS7	48	RTS5	60	GND		

Board Side: RS-422 Pin-out of SCSI 68											
Pin	Signal	Pin	Signal	Pin	Signal	Pin	Signal	Pin	Signal	Pin	Signal
1	TXD6+	13	N/A	25	RXD2+	37	N/A	49	N/A	61	RXD1+
2	TXD6-	14	N/A	26	GND	38	N/A	50	TXD5-	62	N/A
3	N/A	15	N/A	27	RXD0+	39	N/A	51	TXD5+	63	RXD1-
4	N/A	16	TXD4-	28	N/A	40	RXD7-	52	TXD3+	64	N/A
5	N/A	17	TXD4+	29	RXD0-	41	N/A	53	TXD3-	65	N/A
6	RXD6-	18	TXD2+	30	N/A	42	RXD7+	54	N/A	66	N/A
7	N/A	19	TXD2-	31	N/A	43	GND	55	N/A	67	TXD1-
8	RXD6+	20	N/A	32	N/A	44	RXD5+	56	N/A	68	TXD1+
9	GND	21	N/A	33	TXD0-	45	N/A	57	RXD3-		
10	RXD4+	22	N/A	34	TXD0+	46	RXD5-	58	N/A		
11	N/A	23	RXD2-	35	TXD7+	47	N/A	59	RXD3+		
12	RXD4-	24	N/A	36	TXD7-	48	N/A	60	GND		

Board Side: RS-485 Pin-out of SCSI 68											
Pin	Signal	Pin	Signal	Pin	Signal	Pin	Signal	Pin	Signal	Pin	Signal
1	TXD6+/RXD6+	13	N/A	25	N/A	37	N/A	49	N/A	61	N/A
2	TXD6-/RXD6-	14	N/A	26	GND	38	N/A	50	TXD5-/RXD5-	62	N/A
3	N/A	15	N/A	27	N/A	39	N/A	51	TXD5+/RXD5+	63	N/A
4	N/A	16	TXD4-/RXD4-	28	N/A	40	N/A	52	TXD3+/RXD3+	64	N/A
5	N/A	17	TXD4+/RXD4+	29	N/A	41	N/A	53	TXD3-/RXD3-	65	N/A
6	N/A	18	TXD2+/RXD2+	30	N/A	42	N/A	54	N/A	66	N/A
7	N/A	19	TXD2-/RXD2-	31	N/A	43	GND	55	N/A	67	TXD1-/RXD1-
8	N/A	20	N/A	32	N/A	44	N/A	56	N/A	68	TXD1+/RXD1+
9	GND	21	N/A	33	TXD0-/RXD0-	45	N/A	57	N/A		
10	N/A	22	N/A	34	TXD0+/RXD0+	46	N/A	58	N/A		
11	N/A	23	N/A	35	TXD7+/RXD7+	47	N/A	59	N/A		
12	N/A	24	N/A	36	TXD7-/RXD7-	48	N/A	60	GND		

2.1.4 Device Connector Pin-out

MezIO™ C180 Pin-out of DB9 connector			
Pin	RS232	RS422	RS485
	COM1~COM8	COM1~4	COM1~COM4
1	DCD	N/A	N/A
2	RXD	422 TXD+	485 TXD+/RXD+
3	TXD	422 RXD+	N/A
4	DTR	422RXD-	N/A
5	GND	GND	GND
6	DSR	N/A	N/A
7	RTS	N/A	N/A
8	CTS	422 TXD-	485 TXD-/RXD-
9	N/A	N/A	N/A

MezIO™ C181 Pin-out of DB9 connector				
Pin	RS232	RS422		RS485
	COM1~COM4	COM1~4	COM5~8	COM1~COM8
1	DCD	N/A	N/A	N/A
2	RXD	422 TXD+	422 RXD+	485 TXD+/RXD+
3	TXD	422 RXD+	422 TXD+	N/A
4	DTR	422 RXD-	422 TXD-	N/A
5	GND	GND	GND	GND
6	DSR	N/A	N/A	N/A
7	RTS	N/A	N/A	N/A
8	CTS	422 TXD-	422RXD-	485 TXD-/RXD-
9	N/A	N/A	N/A	N/A

2.2 MezIO™ D220/ MezIO™ D230

2.2.1 Specification of MezIO™ D230

Isolated Digital Input	
# of Channel	16
Wiring Type	Sink/ Source Type (only for ch0 to ch7) Sink Type (only for ch8 to ch15)
Interface	Unipolar photo-coupler
Isolation Voltage	3750 Vrms
Rated Input Voltage	24VDC
Max. Input Voltage	24VDC
Logic High Voltage	5 to 24VDC
Logic Low Voltage	0 to 1.5VDC
Operation Mode	Polling
Isolated Digital Output	
# of Channel	16
Wiring Type	Sink Type
Interface	MOSFET, open drain
Isolation Voltage	3750 Vrms
Operation Voltage	24VDC
Max. Driving Voltage	30VDC
Driving Current	500mA for each channel (100% duty)
Operation Mode	Polling
Isolated 5V Output	
Rate Driving Current	100mA
Note	Isolated 5V is used for supplying DO internal chipset ONLY, please make sure it is not driven to external device.

2.2.2 Specification of MezIO™ D220

Isolated Digital Input	
# of Channel	8
Wiring Type	Sink/ Source Type (only for ch0 to ch7)
Interface	Unipolar photo-coupler
Isolation Voltage	3750 Vrms
Rated Input Voltage	24VDC
Max. Input Voltage	24VDC
Logic High Voltage	5 to 24VDC
Logic Low Voltage	0 to 1.5VDC
Operation Mode	Polling
Isolated Digital Output	
# of Channel	8
Wiring Type	Sink Type
Interface	MOSFET, open drain
Isolation Voltage	3750 Vrms
Operation Voltage	24VDC
Max. Driving Voltage	30VDC
Driving Current	500mA for each channel (100% duty)
Operation Mode	Polling
Isolated 5V Output	
Rate Driving Current	100mA
Note	Isolated 5V is used for supplying DO internal chipset ONLY, please make sure it is not driven to external device.

2.2.3 Wiring for Isolated DIO

The digital input function of MezIO™ D220/ D230 series is implemented using a photo-coupler with an internally series-connected 1kΩ resistor. You need to provide a voltage to specify the logic high/low state. The input voltage for logic high is 5~24V and the input voltage for logic low is 0~1.5V. In the MezIO™ D220/ D230, these channels from 0 to 7 support sink/source type (NPN/PNP) which are individual wiring; channels from 8 to 15 only support sink type which share common DIGND.

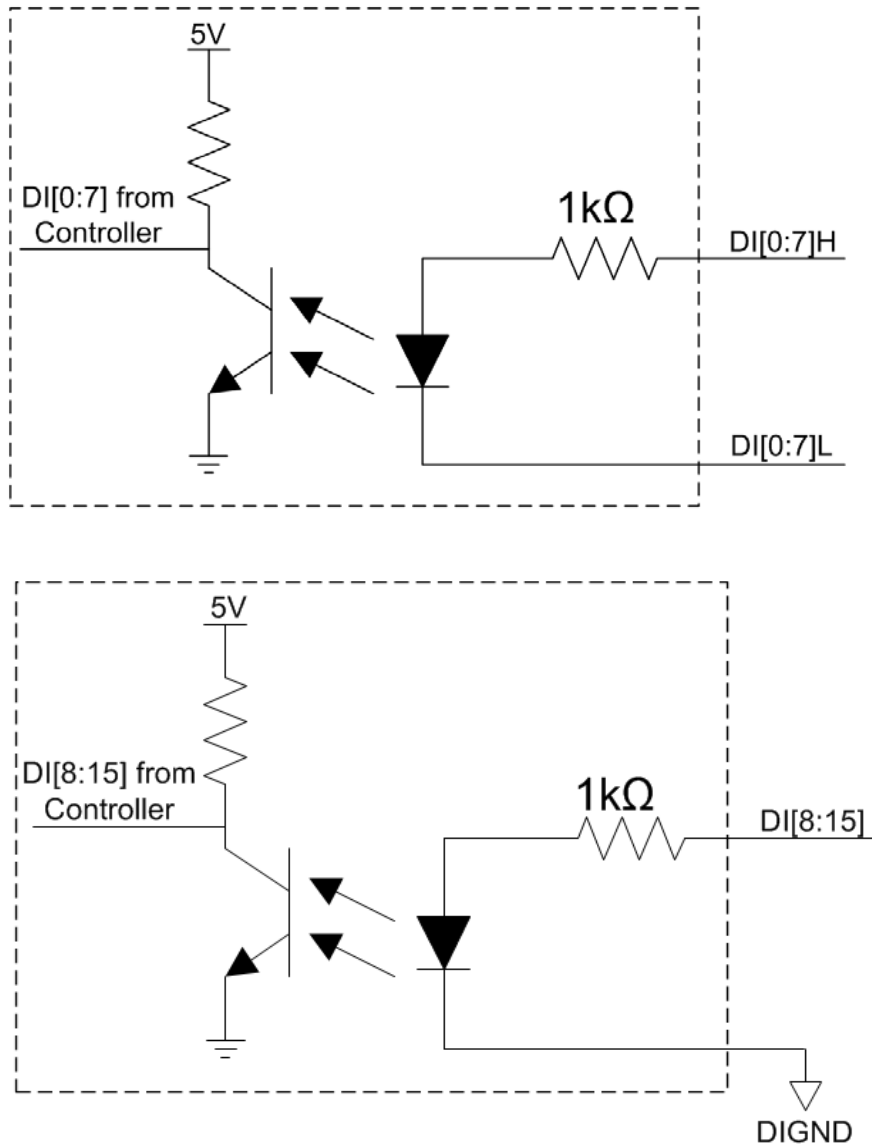

The digital output function of the MezIO™ D220/D230 series is implemented using Power MOSFET + Analog Device iCoupler® component. The DO channels are configured as NO (normally-open) configuration. When you turn on system, all DO channels have a deterministic state of logic 0 (circuit disconnected from GND return). When logic 1 is specified, MOSFET is activated and GND return path is established.

The digital output function on MezIO™ D220/D230 series supports sinking current connection. It also implemented circuit protection, one diode is connected across DO channel and VDD to prevent voltage spike caused by inductive load and long wiring. The following diagram shows the allocated wiring for DO:

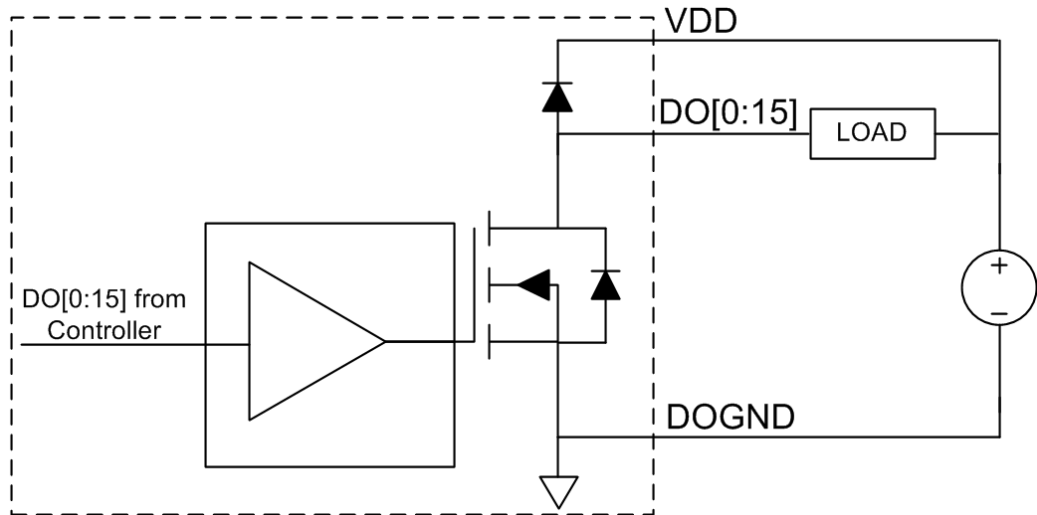

2.2.4 MezIO™ D230 Pin-out

Signal	N/A	DI0H	DI1H	DI2H	DI3H	DI4H	DI5H	DI6H	DI7H	DI8	DIGND	DI10	DIGND	DI12	DIGND	DI14	DIGND
Pin	52	53	54	55	56	57	58	59	60	61	62	63	64	65	66	67	68
Signal	N/A	DI0L	DI1L	DI2L	DI3L	DI4L	DI5L	DI6L	DI7L	DI9	DIGND	DI11	DIGND	DI13	DIGND	DI15	DIGND
Signal	DO0	DOGND	DO2	DOGND	DO4	DOGND	DO6	DOGND	VDD	DOGND	DO8	DOGND	DO10	DOGND	DO12	DOGND	DO14
Pin	1	2	3	4	5	6	7	8	9	10	11	12	13	14	15	16	17
Pin	35	36	37	38	39	40	41	42	43	44	45	46	47	48	49	50	51
Signal	DO1	DOGND	DO3	DOGND	DO5	DOGND	DO7	DOGND	ISO5V	DOGND	DO9	DOGND	DO11	DOGND	DO13	DOGND	DO15

***Note: Terminal board is an accessory provided by Neousys for implementing digital I/O function**

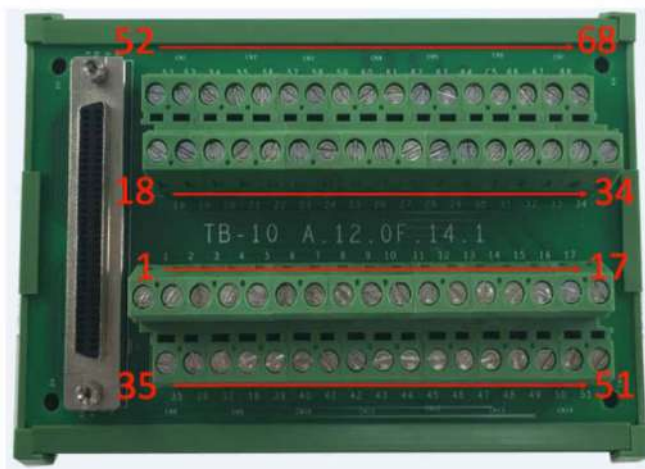

2.2.5 Pin-out of MezIO™ D220

Signal	N/A	DI0H	DI1H	DI2H	DI3H	DI4H	DI5H	DI6H	DI7H	N/A	DIGND	N/A	DIGND	N/A	DIGND	N/A	DIGND
Pin	52	53	54	55	56	57	58	59	60	61	62	63	64	65	66	67	68
Pin	18	19	20	21	22	23	24	25	26	27	28	29	30	31	32	33	34
Signal	N/A	DI0L	DI1L	DI2L	DI3L	DI4L	DI5L	DI6L	DI7L	N/A	DIGND	N/A	DIGND	N/A	DIGND	N/A	DIGND
Signal	DO0	DOGND	DO2	DOGND	DO4	DOGND	DO6	DOGND	VDD	DOGND	N/A	DOGND	N/A	DOGND	N/A	DOGND	N/A
Pin	1	2	3	4	5	6	7	8	9	10	11	12	13	14	15	16	17
Pin	35	36	37	38	39	40	41	42	43	44	45	46	47	48	49	50	51
Signal	DO1	DOGND	DO3	DOGND	DO5	DOGND	DO7	DOGND	ISO5V	DOGND	N/A	DOGND	N/A	DOGND	N/A	DOGND	N/A

***Note: Terminal board is an accessory provided by Neousys for implementing digital I/O function**

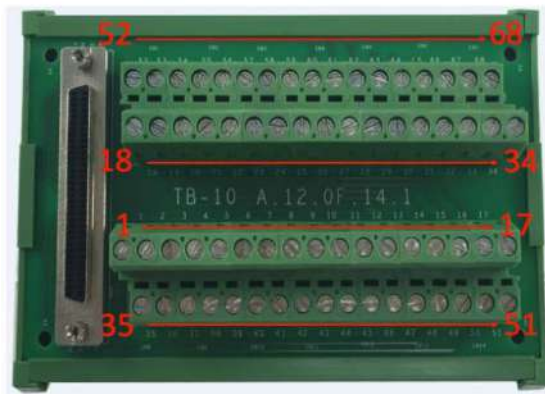

2.2.6 DIO Function Reference

InitDIO

- **Syntax**

BOOL InitDIO(void);

- **Description**

Initialize the DIO function. You should always invoke InitDIO() before write/read any DIO port/channel.

- **Parameter**

None

- **Return Value**

Returns TRUE if initialization successfully, FALSE if initialization failed.

- **Usage**

BOOL bRet = InitWDT()

DIReadLine

- **Syntax**

BOOL DIReadLine(BYTE ch);

- **Description**

Read a single channel of isolated digital input.

- **Parameter**

ch

BYTE value specifies the DI channel to be read. Valid values are 0~3.

- **Return Value**

The status (TRUE or FALSE) of the specified DI channel.

- **Usage**

BYTE ch=3; //DI channel #3

BOOL DIChValue = DIReadLine(ch); //read DI channel #3

DIReadPort

- **Syntax**

WORD DIReadPort(void);

- **Description**

Read the entire isolated digital input port (8 channels).

- **Parameter**

None

- **Return Value**

A WORD value indicates the status of DI port. Return value are 0~255.

- **Usage**

WORD DIPortValue = DIReadPort ();

DOWriteLine

- **Syntax**

void DOWriteLine(BYTE ch, BOOL value);

- **Description**

Write a single channel of isolated digital output.

- **Parameter**

ch

BYTE value specifies the DO channel to be written. Valid value are 0~7.

value

BOOL value (TRUE or FALSE) specifies the status of DO channel.

- **Return Value**

None

- **Usage**

```
BYTE ch=3; //DI channel #3
BOOL DOChValue=TRUE;
DOWriteLine(ch, DOChValue); //write DO channel #3 as TRUE
```

DOWritePort

- **Syntax**

```
void DOWritePort(WORD value);
```

- **Description**

Write the entire isolated digital output port (8 channels).

- **Parameter**

value

WORD value specifies the status of the DO port. Valid values are 0~255.

- **Return Value**

None

- **Usage**

```
WORD DOPortValue=0XFF; //11111111b
DOWritePort(DOPortValue); //write DO port as 11111111b
```

DOWriteLineChecked

- **Syntax**

```
void DOWriteLineChecked(BYTE ch, BOOL value);
```

- **Description**

Write a single channel of isolated digital output and read-back the value of DO register. Note that this function is not returned until the DO register is checked and identical to the written value.

- **Parameter**

ch

BYTE value specifies the DO channel to be written. Valid values are 0~7.

value

BOOL value (TRUE or FALSE) specifies the status of DO channel.

- **Return Value**

None

- **Usage**

```
BYTE ch=3; //DI channel #3
BOOL DOChValue=TRUE;
DOWriteLineChecked(ch, DOChValue); //write DO channel #3 as TRUE
```

● DOWritePortChecked

- **Syntax**

void DOWritePortChecked(WORD value);

- **Description**

Write the entire isolated digital output port (8 channels) and check it has been done.

Note that this function is not returned until the write value has been checked and is the same with the device registry.

- **Parameter**

value

WORD value specifies the status of the DO port. Valid values are 0~255.

- **Return Value**

None

- **Usage**

```
WORD DOPortValue=0XFF; //11111111b
```

```
DOWritePortChecked(DOPortValue); //write DO port as 11111111b
```

2.3 MezIO™ V20 (Nuvo-5000LP/ POC-300 Only)

Nuvo-5000/ POC-300 series with MezIO™ V20 implementation features ignition power control module for in-vehicle applications. It's a MCU-based implementation that monitors the ignition signal and reacts to turn on/off the system according to predefined on/off delay. Its built-in algorithm supports other features such as ultra-low standby power, battery-low protection, system hard-off, etc. In this section, we'll illustrate the principle of ignition power control and operation modes on Nuvo-5000/ POC-300 series with MezIO™ V20.

2.3.1 Specification of MezIO™ V20

Ignition Control	Ignition power control with 15 predefined on/off delay modes
Expansion Bus	
Mini PCI-E	1x full-size mini PCI Express socket (USB signal only)

2.3.2 Internal I/O function

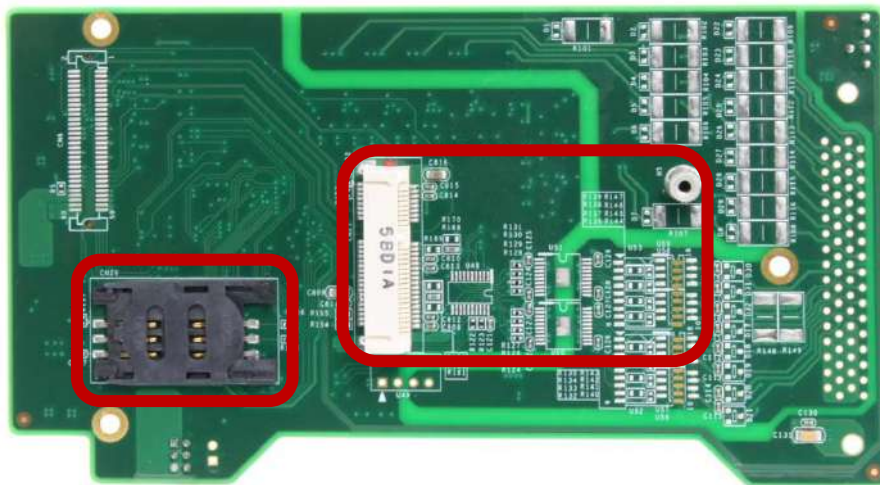

MezIO™ V20 has one full-size mini-PCIe connector (provides USB signals) and one SIM socket. It is designed for installing off-the-shelf LTE/3G/4G/GPRS/GPS SIM card. Once installed, you may connect your system to the internet via your service provider's network.

The following table describes pin definitions of the mini PCIe socket

Pin #	Signal	Pin #	Signal
1	WAKE#	2	+3.3Vaux
3	N/A	4	GND
5	N/A	6	+1.5V
7	N/A	8	UIM_PWR
9	GND	10	UIM_DATA
11	N/A	12	UIM_CLK
13	N/A	14	UIM_RESET
15	GND	16	UIM_VPP
17	N/A	18	GND
19	N/A	20	W_DISABLE#
21	GND	22	N/A
23	N/A	24	+3.3Vaux
25	N/A	26	GND
27	GND	28	+1.5V
29	GND	30	N/A
31	N/A	32	N/A
33	N/A	34	GND
35	GND	36	USB_D-
37	GND	38	USB_D+
39	+3.3Vaux	40	GND
41	+3.3Vaux	42	LED_WWAN#
43	GND	44	LED_WLAN#
45	Reserved	46	LED_WPAN#
47	Reserved	48	+1.5V
49	Reserved	50	GND
51	Reserved	52	+3.3Vaux

2.3.3 Principle of Ignition Power Control

The basic concept of ignition power control module is to control the timing correlation between ignition signal and system power status. A typical timing correlation is shown in following diagram.

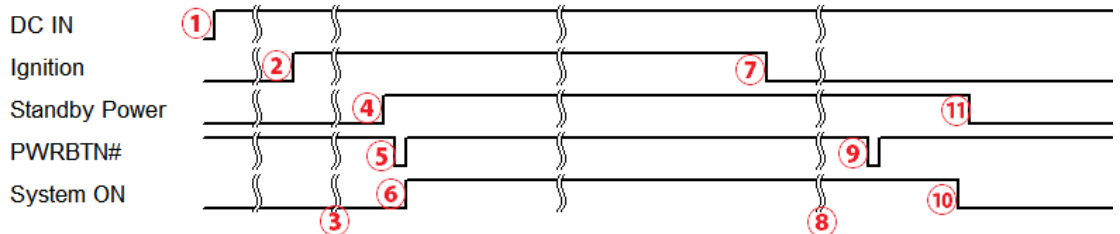

1. When DC input is supplied to Nuvo-5000 series with MezIO™ V20, MCU starts to periodically detect ignition signal. Note that only MCU is working at this moment and the overall power consumption is less than 2 mW.
2. Ignition signal activated (both 12VDC and 24VDC ignition signals are accepted).
3. MCU starts to countdown according to a predefined power-on delay.
4. Once power-on delay expires, MCU turns on necessary standby power for Nuvo-5000 series (3.3VSB & 5VSB).
5. A PWRBTN# pulse is then issued to turn on the system (equivalent to pressing the power button on the front panel).
6. Nuvo-5000 series boots and runs.
7. After a period of time, the ignition signal is inactive.
8. MCU starts to countdown according to a predefined power-off delay.
9. Once power-off delay expires, another PWRBTN# pulse is issued to perform a soft-off for the system (equivalent to Windows shutdown process).
10. Nuvo-5000 series is completely shut down.
11. As MCU detects system is off, it turns off the standby power for Nuvo-5000 series, and then operates in low power mode again (< 2mW power consumption).

In addition to the typical timing correlation, the ignition power control module offers other features that make Nuvo-5000/ POC-300 series more reliable for in-vehicle applications.

1. **Low battery detection**

The ignition power control module can continuously monitor the voltage of DC input while the system is running. If input voltage is less than 9V (for 12VDC input) or less than 18V (for 24VDC input) over a 60 second duration, it will shut down the system automatically.

2. **Power on/ off delay duration protection mechanism**

If ignition signal goes inactive during the power-on delay duration, the ignition power control module will cancel the power-on delay process and go back to idle status. Likewise, if ignition signal goes active during the power-off delay duration, the ignition power control module will cancel the power-off delay process and keep the system running.

3. **System hard-shutdown**

In some cases, system may fail to shutdown via a soft-shutdown command operation due to system/application halts. The ignition power control module on Nuvo-5000/ POC-300 series with MezIO™ V20 offers a mechanism called “hard-shutdown” to handle this unexpected condition. By detecting the system status, it can determine whether the system has successfully shutdown after a “soft-shutdown” command has been issued. If not, the ignition power control module will cut off the system power 10 minutes after the power-off delay duration.

4. **Smart off-delay**

The ignition power control module on Nuvo-5000/ POC-300 series offers two modes (mode 6 & mode 7) which have very long power-off delay duration for applications requiring off-line processing after the vehicle has stopped. In these two modes, the ignition power control module will automatically detect the system status during the power-off delay duration. If the system shuts down (by the application software) before power-off delay expires, it will cut off the system power immediately to prevent further consumption of battery power.

2.3.4 Ignition Signal Wiring



To setup ignition power control for in-vehicle use, you need to supply IGN signal to Nuvo-5000/ POC-300 series with MezIO™ V20 installed. The IGN input is located on the back panel via a 3-pin pluggable terminal block (shared with DC power input). Here is a general wiring configuration for in-vehicle application deployment.

1. Connect car Battery+ line (12V for sedan, 24V for bus/truck) to V+.
2. Connect car Battery-/GND line to GND.
3. Connect ACC line to IGN.



WARNING

Please make sure your DC power source and IGN signal share a common ground.

*IGN input of Nuvo-5000/ POC-300 series accepts 8~35VDC. **DO NOT** supply a voltage higher than 35VDC as it may damage the system!*

2.3.5 Operation Modes of Ignition Power Control

Once you have installed the MezIO™ V20 module with ignition power control, you can use the rotary switch on the rear panel to configure operation modes. Nuvo-5000/ POC-300 series with MezIO™ V20 with ignition power control offers 15 operation modes with different power-on/ power-off delay configurations.

Ignition Mode Selections for MezIO™ V20

- **Mode 0**

Mode 0 is the ATX mode without power-on and power-off delay. User can only use the power button on the front panel to turn on or turn off the system.

Mode	Power-on Delay	Power-off Delay	Hard-off Timeout
0	N/A	N/A	N/A

- **Mode 1**

If Mode 1 is specified, the system automatically turns on the system when DC power is applied. A retry mechanism is designed to repeat the power-on cycle if the system fails to boot.

Mode	Power-on Delay	Power-off Delay	Hard-off Timeout
1	N/A	N/A	N/A

- **Mode 2**

Mode 2 is a special mode designed to support remote on/ off control. User can use an external switch to connect to the DC source (8~35V) and IGN input. When the switch is closed, IGN signal is asserted to initiate a power-on operation. When the switch is opened, IGN signal is de-asserted and system shutdown operation is initiated. Neither power-on delay nor power-off delay is supported in this mode.

Mode	Power-on Delay	Power-off Delay	Hard-off Timeout
2	N/A	N/A	N/A

- **Mode 3 ~ Mode 12**

Mode 3 ~ Mode 12 are ignition power control modes with various power-on and power-off delay. Each mode supports a hard-off timeout of 10 minutes.

Mode	Power-on Delay	Power-off Delay	Hard-off Timeout
3	10 seconds	10 seconds	10 minutes
4	10 seconds	1 minute	10 minutes
5	10 seconds	5 minutes	10 minutes
6	30 seconds	1 minute	10 minutes
7	30 seconds	5 minutes	10 minutes
8	30 seconds	10 minutes	10 minutes
9	3 minutes	1 minute	10 minutes
10	3 minutes	10 minutes	10 minutes
11	3 minutes	30 minutes	10 minutes
12	10 minutes	30 minutes	10 minutes

- **Mode 13 / Mode 14**

Mode 13 and Mode 14 are ignition power control modes with very long power-off delay. Both modes support the feature of “intelligent-off delay”, which automatically detects the system status during power-off delay duration and cut off system power if system has shutdown (soft-off), prior to power-off delay expires.

Mode	Power-on Delay	Power-off Delay	Hard-off Timeout
13	30 seconds	2 hours	10 minutes
14	3 minutes	2 hours	10 minutes

2.3.6 Configure Your Windows System

When applying ignition power control to your system, please make sure you've configured your Windows system to initiate a shutdown process when pressing the power button. By default, Windows 7/ 8/ 10 goes to sleep (S3) mode when power button is pressed. As sleep (S3) is not a complete shutdown behavior, the ignition control function does not recognize when a normal shutdown process has finished and thus users will encounter a system hard-off (power cut-off after 10 minutes).

Please configure the setting "When I press the power button" to "Shut down" in your Windows system by going to (Control Panel > Hardware and Sound > Power Options > Choose what the power button does).



In the next screen "Define power buttons and turn on password protection", you should see "When I press the power button" option. Please set it to "**Shut down**".

Define power buttons and turn on password protection

Choose the power settings that you want for your computer. The changes you make to the settings on this page apply to all of your power plans.

Power button settings



When I press the power button:

Shut down



2.4 MezIO™ R10 (POC-120MZ Only)

2.4.1 Specification of MezIO™ R10 (Nuvo-5000LP Only)

Storage Interface	
SATA HDD	1x internal SATA port for 2.5" HDD/SSD
Expansion Bus	
Mini PCI-E	1x full-size mini-PCIe port with SIM socket (mini-PCIe and USB signals)

2.4.2 Internal I/O Functions

MezIO™-R10 provides additional useful features via its board-to-board connector, such as SATA ports, mini-PCIe sockets, etc. In this section, we'll illustrate these internal I/O functions.

1. SATA Port for Internal HDD/SSD

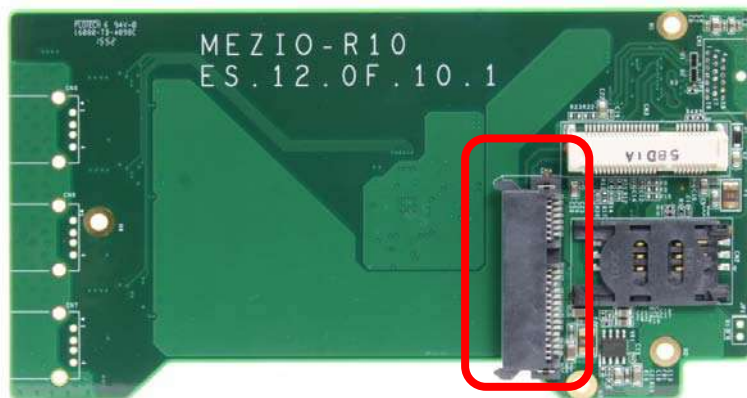

MezIO™ R10 provides internal SATA ports to accommodate one 2.5" HDD/SSD.

2. Full-Size Mini-PCIe Connector (with SIM Socket)



MezIO™-R10 provides 1 mini-PCle socket that supports mini-PCle and USB signals. This mini-PCle socket is designed with SIM card support. With a SIM card installed, it's capable to connect your system to the Internet through your service provider's 3G/4G network. For WIFI/3G/4G network, Nuvo-5000 series provides multiple SMA antenna apertures on the front and back panel for multi-antenna configuration.

The following table describes the pin definition of mini-PCle socket.

Pin	Signal	Pin #	Signal
1	WAKE#	2	+3.3Vaux
3	COEX1	4	GND
5	COEX2	6	+1.5V
7	CLKREQ#	8	UIM PWR
9	GND	10	UIM DATA
11	REFCLK-	12	UIM CLK
13	REFCLK+	14	UIM RESET
15	GND	16	UIM VPP
17	Reserved* (UIM C8)	18	GND
19	Reserved* (UIM C4)	20	W DISABLE#
21	GND	22	PERST#
23	PERn0	24	+3.3Vaux
25	PERp0	26	GND
27	GND	28	+1.5V
29	GND	30	SMB CLK
31	PETn0	32	SMB DATA
33	PETp0	34	GND
35	GND	36	USB D-
37	GND	38	USB D+
39	+3.3Vaux	40	GND
41	+3.3Vaux	42	LED WWAN#
43	GND	44	LED WLAN#
45	Reserved	46	LED WPAN#
47	Reserved	48	+1.5V
49	Reserved	50	GND
51	Reserved	52	+3.3Vaux



NOTE

Some off-the-shelf mini-PCle 4G modules are not compliant to standard mini-PCle interface. They use 1.8V I/O signals instead of standard 3.3V I/O, and may have signal conflict on certain pins. Please make sure your 4G module has the correct pin definition or consult Neousys for compatibility. Installing an incompatible 4G module may damage the system or the module itself.

2.5 MezIO™-G4P/ G4

2.5.1 Specification of MezIO-G4P

MezIO - G4P	
Gigabit Ethernet Port	4x GigE ports by 4x Intel® I210 controllers, supporting 9.5 kB jumbo frame
PoE Capability	Compliant with IEEE 802.3at-2009 (PoE+), each port delivers up to 25.5 W of power
Cable Requirement	CAT-5e or CAT-6 cable, 100 meters maximal

2.5.2 Specification of MezIO-G4

MezIO - G4	
Gigabit Ethernet Port	4x GigE ports by 4x Intel® I210 controllers, supporting 9.5 kB jumbo frame
Cable Requirement	CAT-5e or CAT-6 cable, 100 meters maximal

2.6 MezIO™-U4-30/ 50

2.6.1 Specification of MezIO™-U4-30

MezIO-U4-30	
USB Ports	4x USB 3.0 ports, compatible with USB 2.0/1.1/1.0
USB Controller	2 x Renesas μPD720202 Host Controllers
USB Connectors	4x USB 3.0 Type-A connectors
USB Per-Port Current Limit	900mA
Bandwidth	5 Gbps shared by two ports

2.6.2 Specification of MezIO™-U4-50

MezIO-U4-50	
USB Ports	4x USB 3.0 ports, compatible with USB 2.0/1.1/1.0
USB Controller	4 x Renesas μPD720202 Host Controllers
USB Connectors	4x USB 3.0 Type-A connectors
USB Per-Port Current Limit	900mA
Bandwidth	5 Gbps per port

3 MezIO™ Module Installation

Neosys MezIO™ modules are designed easy-to-installation and offer application-oriented practicality and expandability for Nuvo-5000E/P, Nuvo-5000L/P, Nuvo-5095C, POC-120 and POC-300. In this chapter, we will demonstrate how to disassemble the system and gain access to the MezIO™ port for module installation. Before you start, please make sure you have done the following:

- It is recommended that only qualified service personnel should install and service this product to avoid injury.
- During the process, please observe all ESD procedures to avoid damaging the equipment.
- Before disassembling your system, please make sure the system has powered off with all cables and antennae (power, video, data, etc.) are disconnected.
- Place the system on a flat and sturdy surface (remove from mounts or out of server cabinets) before proceeding with the installation/ replacement procedure.

**NOTE**

For installing MezIO™ modules into Nuvo-7000 series, please refer to your system's respective manuals.

3.1 POC-120MZ MezIO™ Installation/ Replacement

To access the MezIO™ module/ interface in POC-120MZ, you need to disassemble the POC-120MZ system enclosure:

1. To disassemble POC-120MZ, locate and unfasten the four (4) indented hex bolts on the heat sink side.



2. Holding the enclosure with VGA port facing you, place both your thumbs on the heat sink and gently slide the panel and PCBA/ heat sink out of the enclosure.



3. Unfasten the thumb screw to separate the panel from the PCBA/ heat sink.



4. Once the panel has been removed, the MezIO™ port and standoffs are exposed, you are ready to install the MezIO™ module.



5. Once you have gain access to the PCBA, you may perform the following procedures:
 - a) **To replace**, unfasten the three (3) screws securing the existing MezIO™ module, gently lift the module to disengage the MezIO™ connector.
 - b) **To install**, match the MezIO™ port and three (3) screw holes (indicated by black arrows) to the standoffs, gently lower the module onto the PCBA. The MezIO™ port should engage if the three (3) standoffs and screw holes meet. Secure the module by fastening a screw on each standoff.



6. You may need to swap the I/O shield with the replacement I/O shield supplied if the replacement MezIO™ is different to the one you had installed. To do so, unfasten the thumb screw, remove the existing I/O shield and replace it with the one supplied and secure by fastening the thumb screw.



7. To put the system back together, slide the PCBA/ heat sink back into the enclosure and fasten the four (4) indented hex bolts on the heat sink side.

3.2 POC-300 MezIO™ Installation/ Replacement

To access the MezIO™ module/ interface in POC-300, you need to disassemble the POC-300 system enclosure:

1. To disassemble POC-300, unfasten the three (3) screws shown in the illustration A and the two (2) screws shown in illustration B, below.



Illustration A



Illustration B

2. Gently slide the L-shaped enclosure open.



3. Once you have gain access to the PCBA, you may perform the following procedures:
 - a) **To replace**, you need to unfasten the three (3) screws securing the existing MezIO™ module, gently lift the module to disengage the MezIO™ connector.
 - b) **To install**, match the three (3) screw holes (indicated by black arrows) to the standoffs and the MezIO™ port, gently lower the module onto the PCBA. The MezIO™ port should engage if the three (3) standoffs and screw holes meet. Then using the three (3) screws supplied, secure the module by fastening a screw on each standoff.



4. If you are installing a new MezIO™ module into your system, you'll need to remove the I/O shield opening for the connector.



5. Slide the L-shaped enclosure back in place. Make sure the screw hole on the hinge sits on the inside when reinstalling the enclosure.



6. Complete the procedure by fastening the five (5) screws used earlier.



3.3 Nuvo-5000 Series Disassembly Procedure

The Nuvo-5000 series disassemble procedure section will demonstrate how to remove the necessary enclosure panel(s) to gain access to Nuvo-5000E/P, Nuvo-5000LP and Nuvo-5095GC systems' PCBA. The MezIO™ module installation section will be demonstrated in the [following chapter](#).

3.3.1 Nuvo-5000E/P Series

1. Place the Nuvo-5000E/P controller upside down on a flat and secured surface.
2. Unfasten four (4) M3 flat-head screws and detach the Cassette enclosure by gently lifting it off the system enclosure.



3. Unfasten seven (7) indented hex bolts each, on the front and rear panel, remove both front and rear panel.





4. Gently lift and remove the bottom cover of Nuvo-5000E/P controller to expose the controller's PCBA and MezIO™ port.

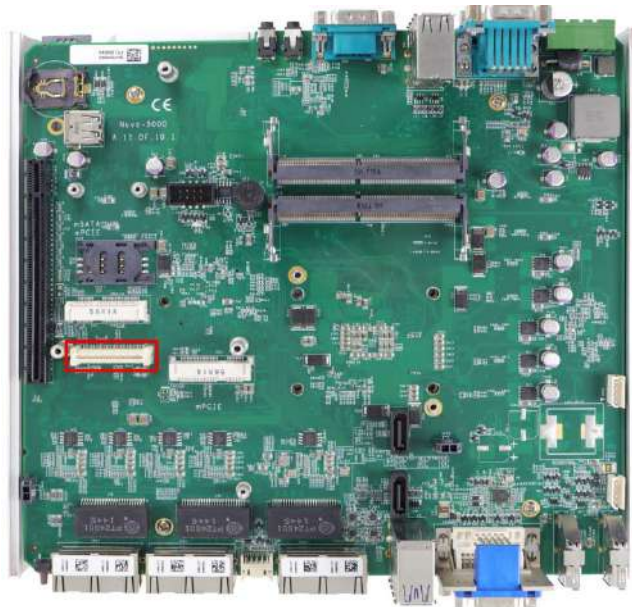
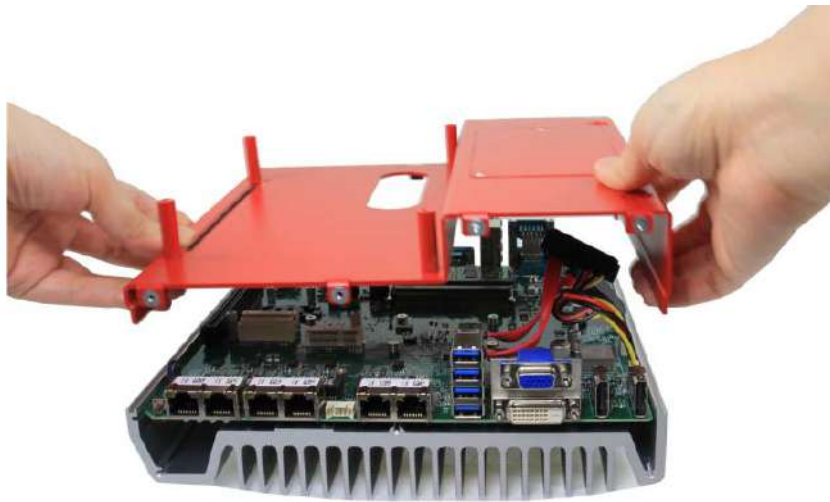

5. For Nuvo-5000 series MezIO™ module installation procedure, please go [here](#).

3.3.2 Nuvo-5000LP Series

1. Place the Nuvo-5000LP controller upside down on a flat and secured surface.
2. Unfasten six (6) indented hex bolts on the front and rear panel, remove both front and rear panel.



3. Remove the bottom cover of Nuvo-5000LP controller and the SATA cable attached to the hot-swappable HDD tray to expose the controller's PCBA and MezIO™ port.

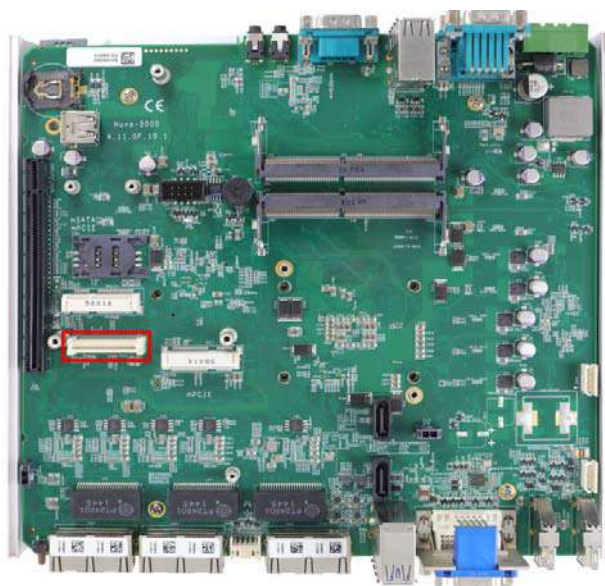
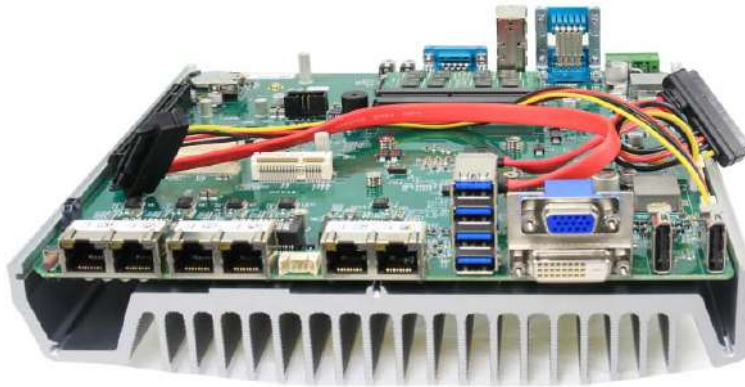

4. For installation of the MezIO™ module, please go [here](#).

3.3.3 Nuvo-5095GC Series

1. Place the Nuvo-5095GC controller upside down on a flat and secured surface.
2. Unfasten four (4) M3 flat-head screws and detach Cassette by gently lifting it off the system enclosure.



3. Unfasten seven(7) indented hex bolts on the front and rear panel, remove both front and rear panel.



4. Remove the bottom cover of Nuvo-5095GC controller to expose the PCBA and MezIO™ port.

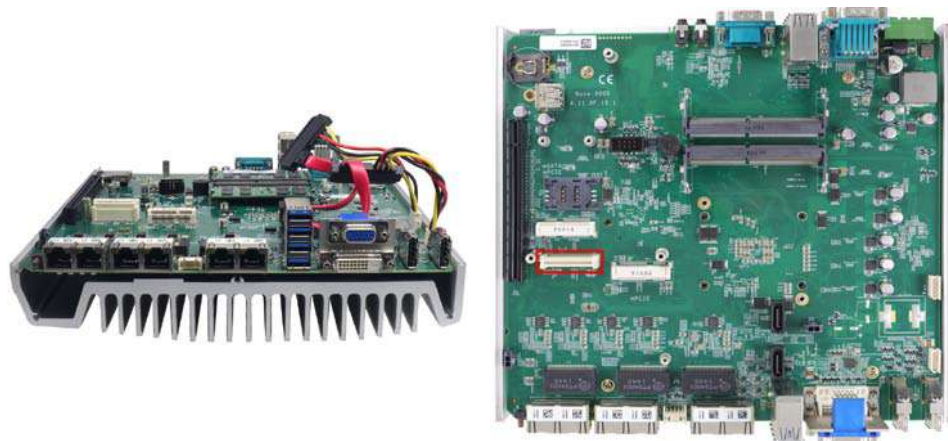

5. For installation of the MezIO™ module, please go [here](#).

3.3.4 Nuvo-5000 Series MezIO™ Module Installation

1. On the PCBA board, locate the MezIO™ port and the three (3) standoffs.

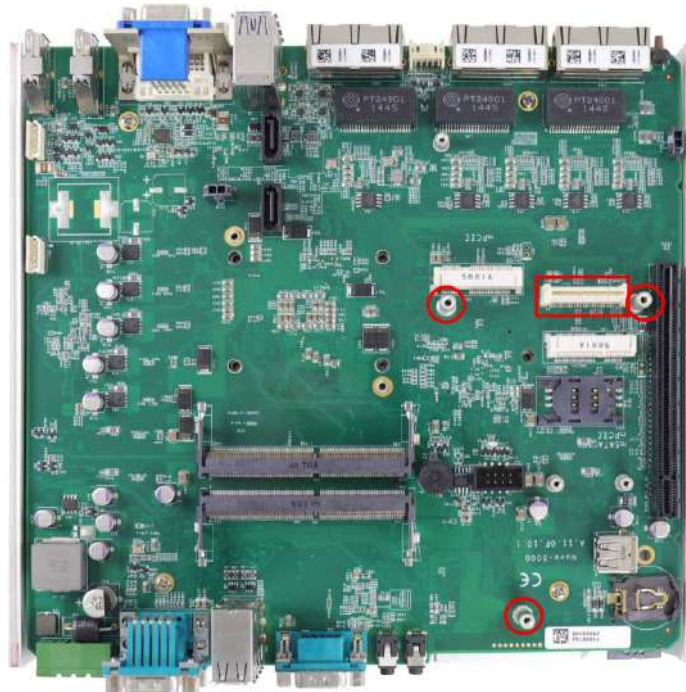

2. **To install**, match the MezIO™ port and three (3) screw holes (indicated by black arrows) to the standoffs, gently lower the module onto the PCBA/ heat sink component. The MezIO™ port should engage if standoffs and screw holes meet. Then using the three (3) screws supplied, secure the module by fastening a screw on each standoff.



3. Once you have installed the MezIO™ module, you can reinstall the removed panel(s) and enclosure(s) by referencing steps performed earlier to remove them!
4. Reinstall the enclosure when done.

3.4 Nuvo-7000 Series Disassembly Procedure

The Nuvo-7000 series disassemble procedure section will demonstrate how to remove the necessary enclosure panel(s) to gain access to Nuvo-7000E/ P/ DE/ LP and Nuvo-7160GC systems' PCBA.

3.4.1 Nuvo-7000E/ P/ DE/ LP

To access system's MezIO™ interface, the system needs to be disassembled. To disassemble the system enclosure, you need to remove the Cassette module and screws on both I/O panels.

1. Turn the system upside-down and remove the four screws at the bottom of the Cassette module.



NOTE

Not applicable to Nuvo-7000LP systems.



- Gently wiggle and separate the Cassette module from the system.



NOTE

Not applicable to Nuvo-7000LP systems.



- On the front I/O panel, remove the hexa-screws indicated below.



Nuvo-7000E/ P/ DE systems



Nuvo-7000LP systems

4. Remove the front I/O panel.



Nuvo-7000E/ P/ DE systems



Nuvo-7000LP systems

5. On the rear I/O panel, remove the hexa-screws indicated below.



Nuvo-7000E/ P/ DE systems



Nuvo-7000LP systems

6. Remove the rear I/O panel.

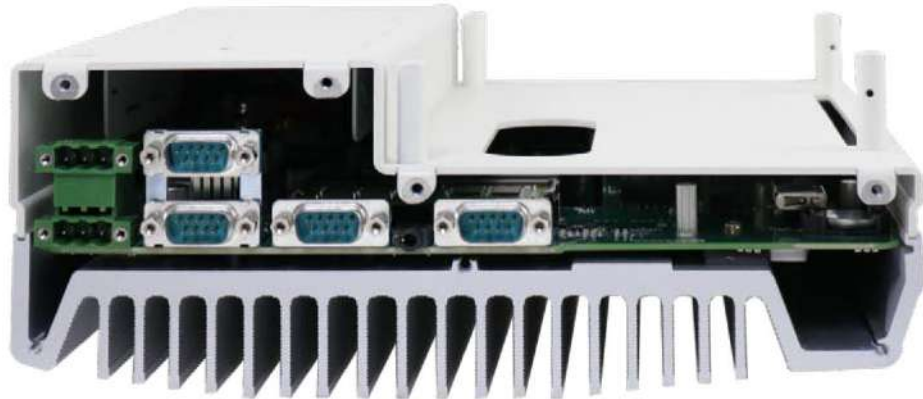

Nuvo-7000E/ P/ DE systems



Nuvo-7000LP systems

7. Gently lift the system's bottom panel.

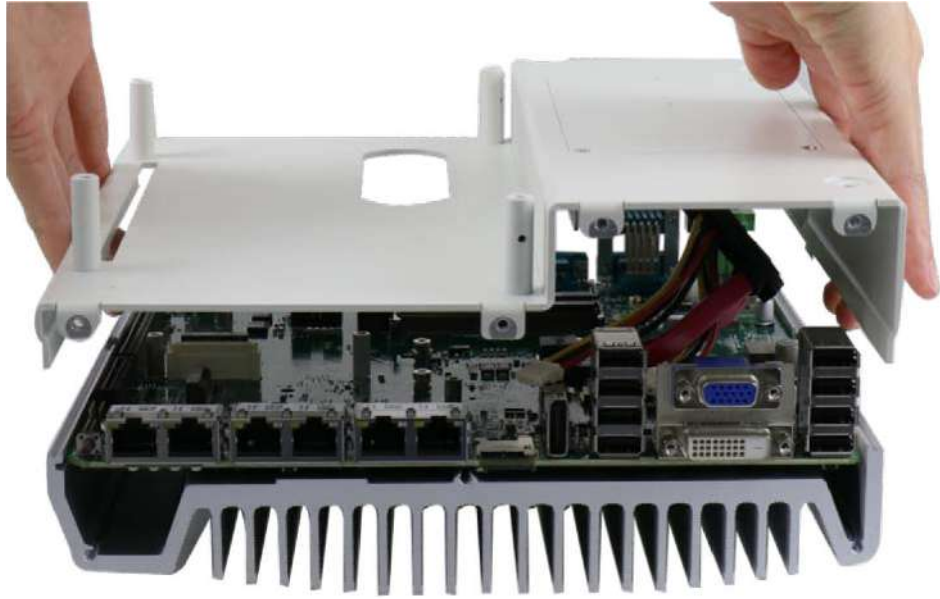

Nuvo-7000E/ P/ DE systems



Nuvo-7000LP systems



NOTE

For Nuvo-7000LP systems, please disengage the 22-pin SATA cable connected to the 2.5" hot swappable tray before removing the bottom panel.

8. Once the bottom panel has been removed, you should have access to the system's MezIO™ interfaces.

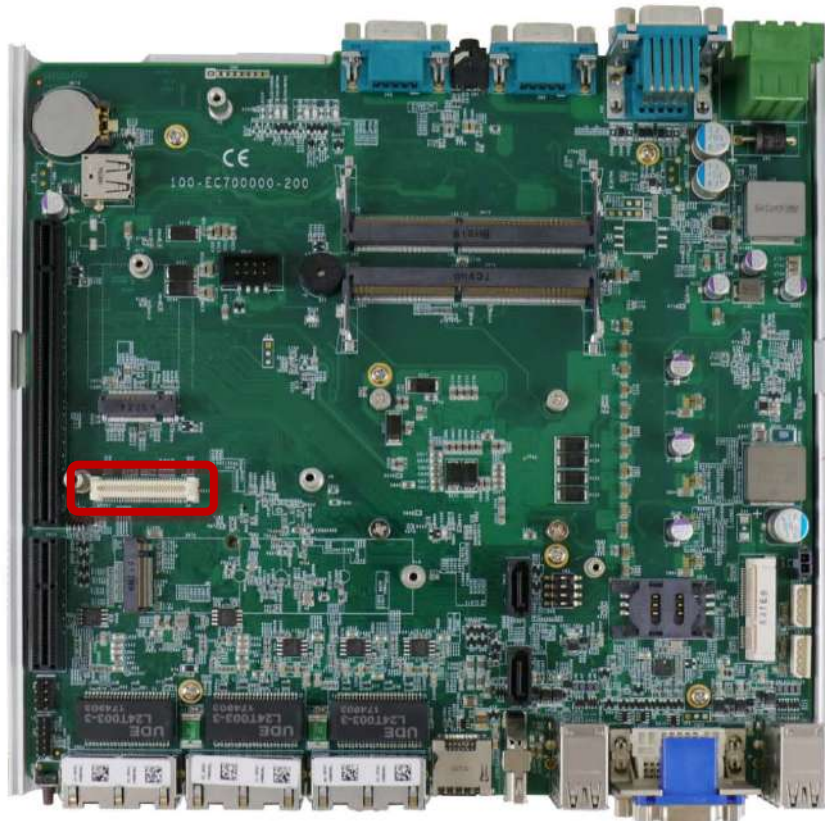

3.4.2 Nuvo-7000E/ P/ DE/ LP MezIO™ Module Installation

1. The MezIO™ module is secured by the three stand-mounts indicated in the illustration below.

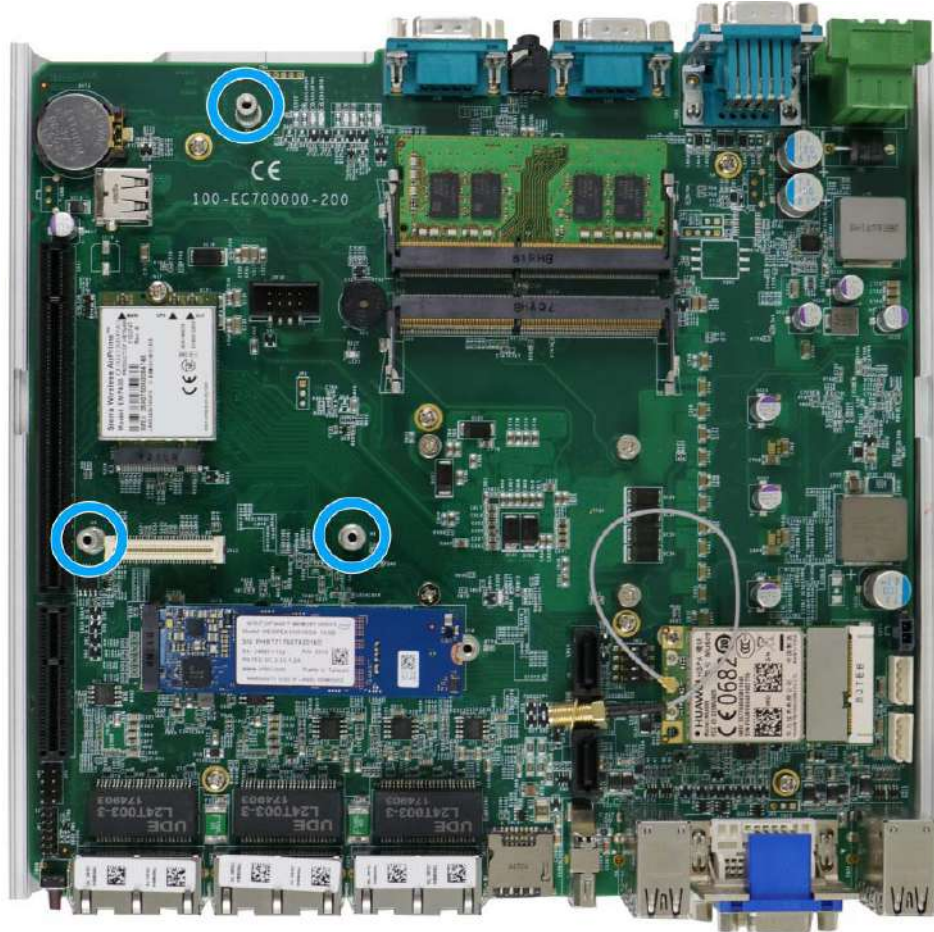

2. Gently lower the MezIO™ module onto the three stand-mounts while matching the MezIO™ interface. Secure the module using three screws supplied.

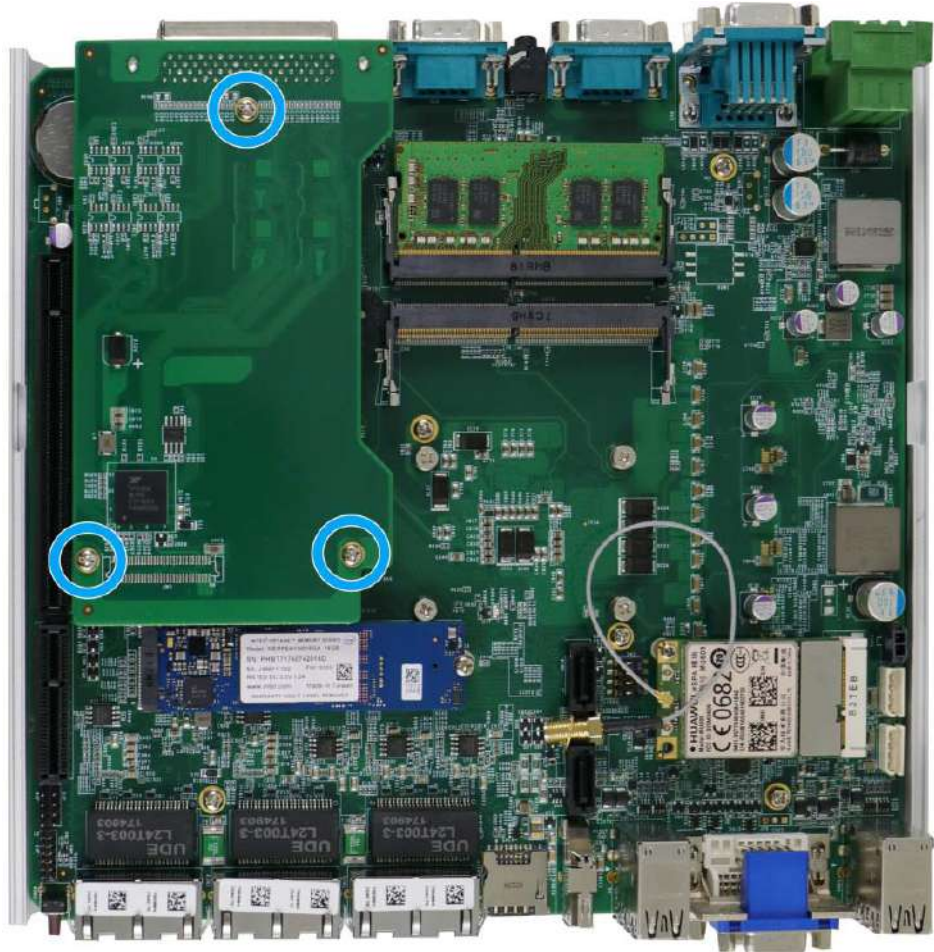

3. Reinstall the system enclosure and panel when done. To reinstall the system enclosure, place the bottom panel on top of the motherboard while making sure both sides are inserted into the heatsink (indicated in **blue**).

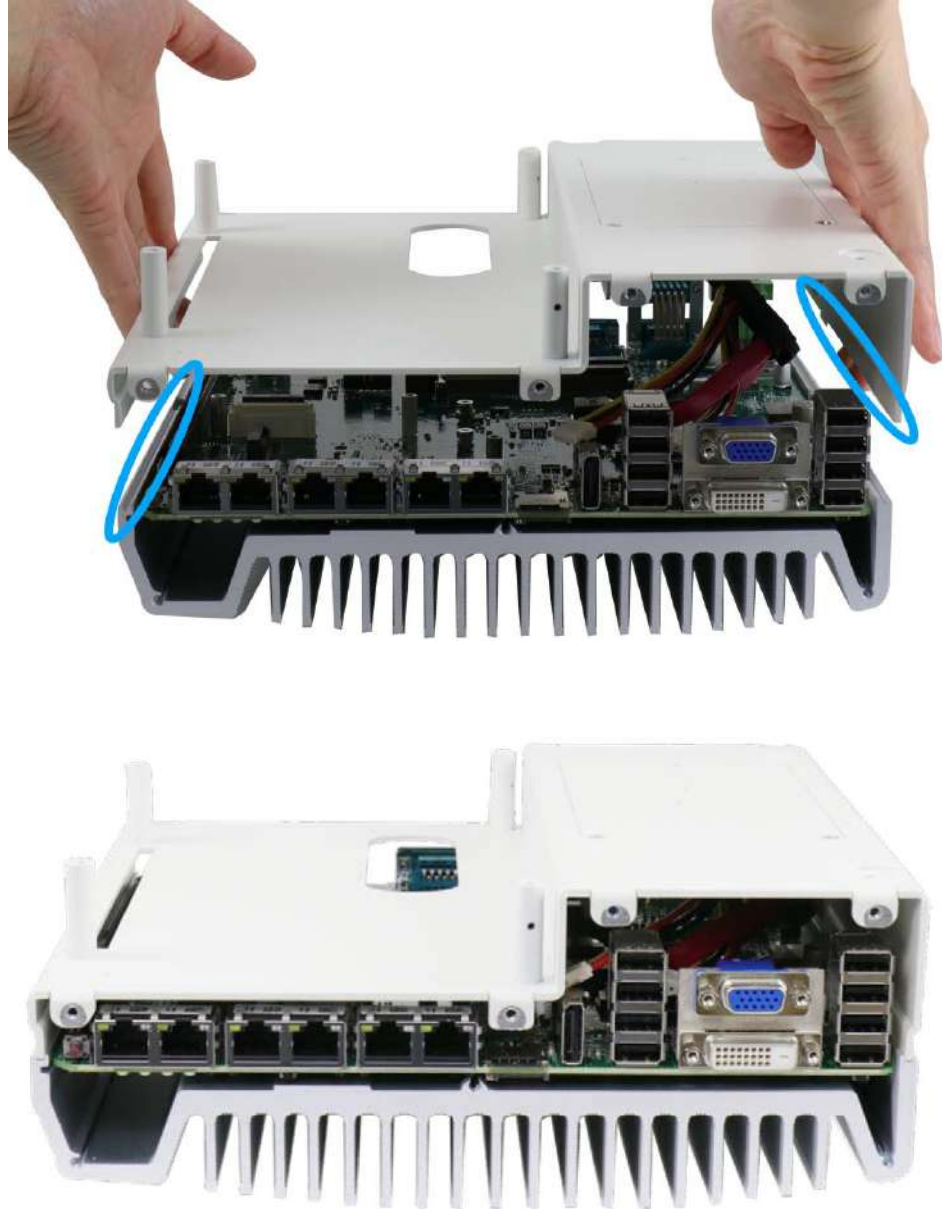

Nuvo-7000E/ P/ DE systems



Nuvo-7000LP systems



NOTE

For Nuvo-7000LP systems, please connect the 22-pin SATA cable connected to the 2.5" hot swappable tray before installing the bottom panel.

4. Install the front panel and secure screws indicated in blue.



Nuvo-7000E/ P/ DE systems



Nuvo-7000LP systems

5. Install the rear panel and secure screws indicated in **blue**.



Nuvo-7000E/ P/ DE systems



Nuvo-7000LP systems

6. Install the Cassette module and secure screws indicated in **blue**.



NOTE

Not applicable to Nuvo-7000LP systems.



3.5 Nuvo-7160GC Series Disassembly Procedure

To access system's MezIO™ interface, the system needs to be disassembled. To disassemble the system enclosure, you need to remove the Cassette module and screws on both I/O panels.

3.5.1 Nuvo-7160GC

1. Turn the system upside-down and remove the four screws at the bottom of the Cassette module.



2. Gently wiggle and separate the Cassette module from the system.



3. On the rear I/O panel, remove the hexa-screws indicated below.



4. Remove the rear I/O panel.

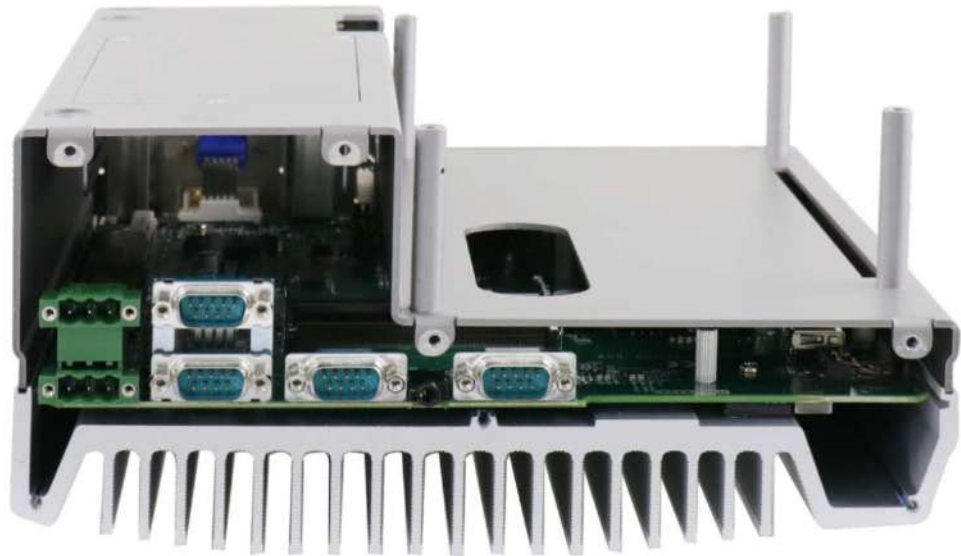

5. On the front I/O panel, remove the hexa-screws indicated below.



6. Remove the front I/O panel.



7. Gently lift the system's bottom panel.

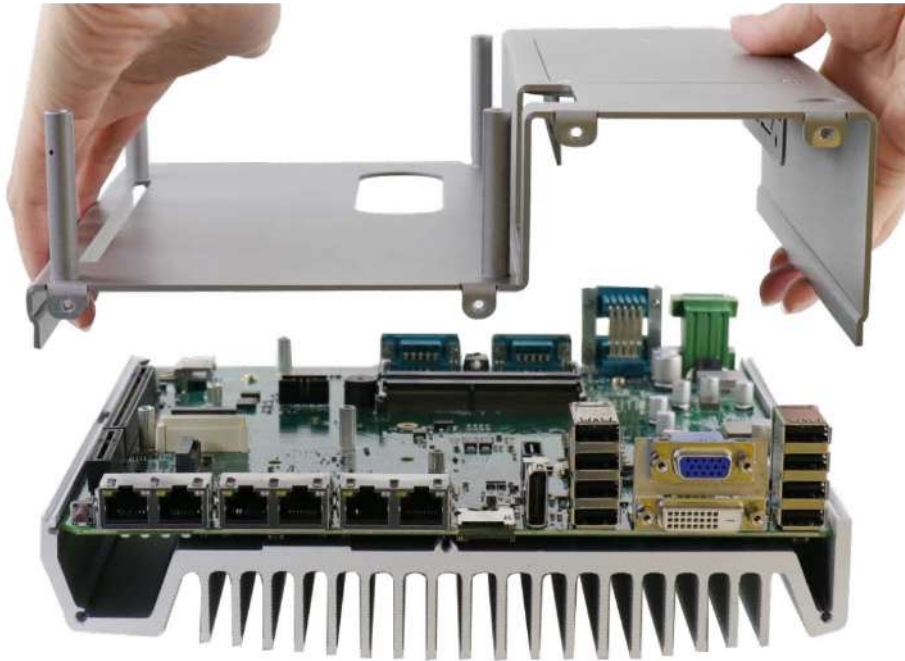

8. Once the bottom panel have been removed, you should have access to the system's internal I/O interfaces.

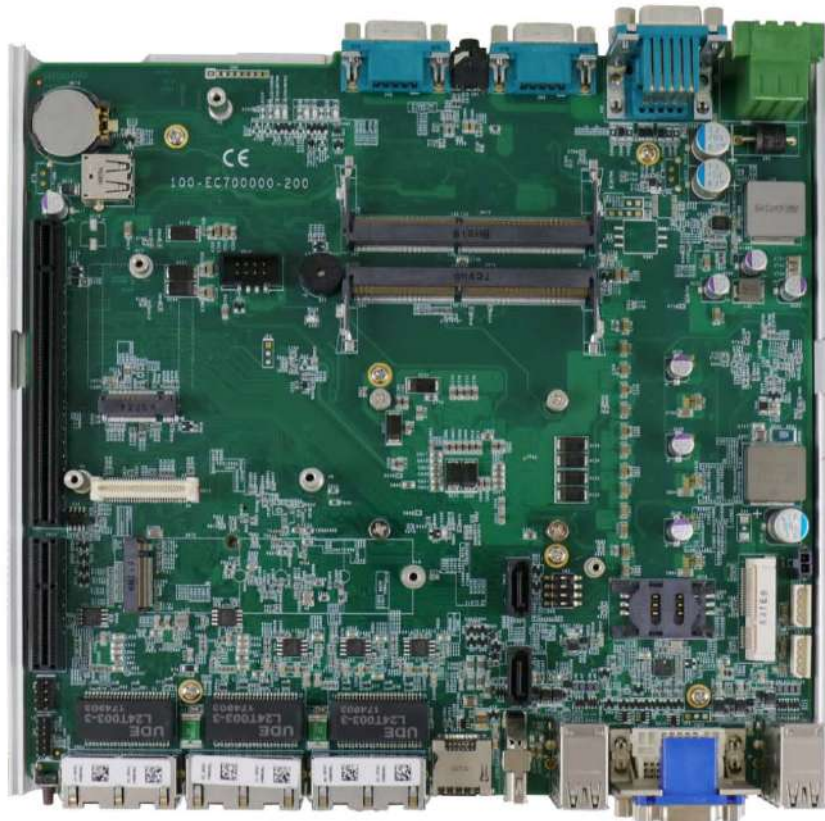

3.5.2 Nuvo-7160GC MezIO™ Installation

1. The MezIO™ module is secured by the three stand-mounts indicated in the illustration below.

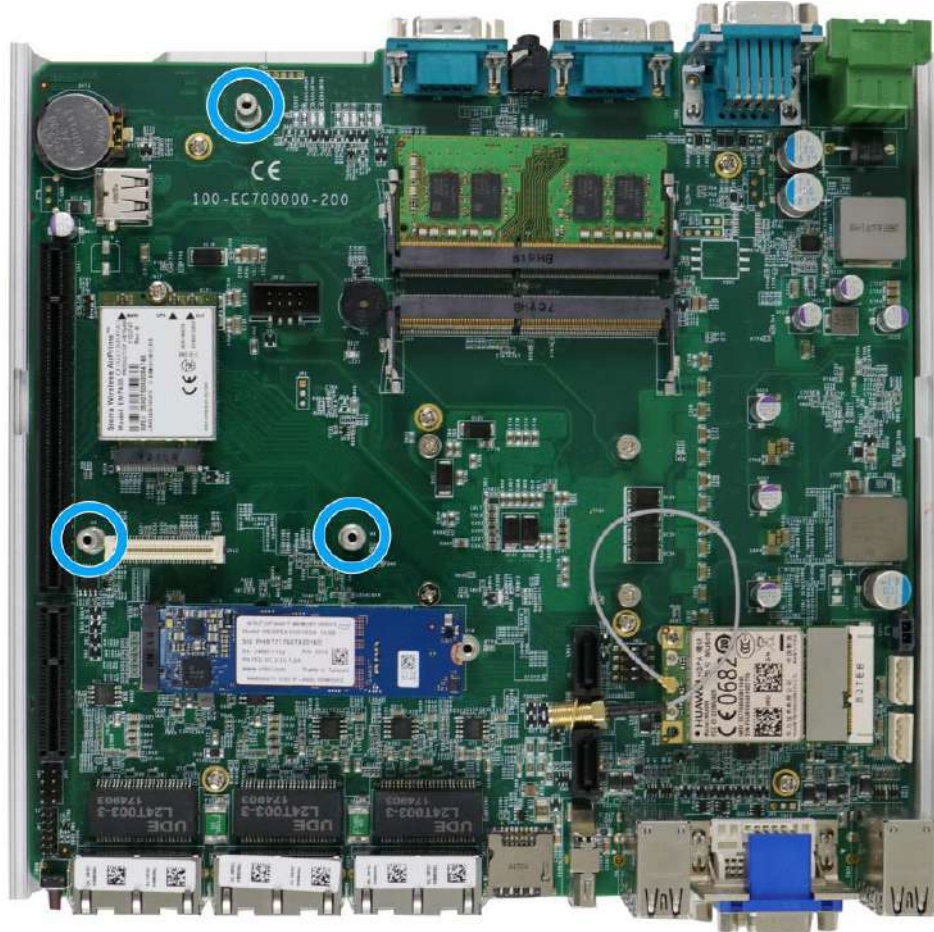

2. Gently lower the MezIO™ module onto the three stand-mounts while matching the MezIO™ interface. Secure the module using three screws supplied.

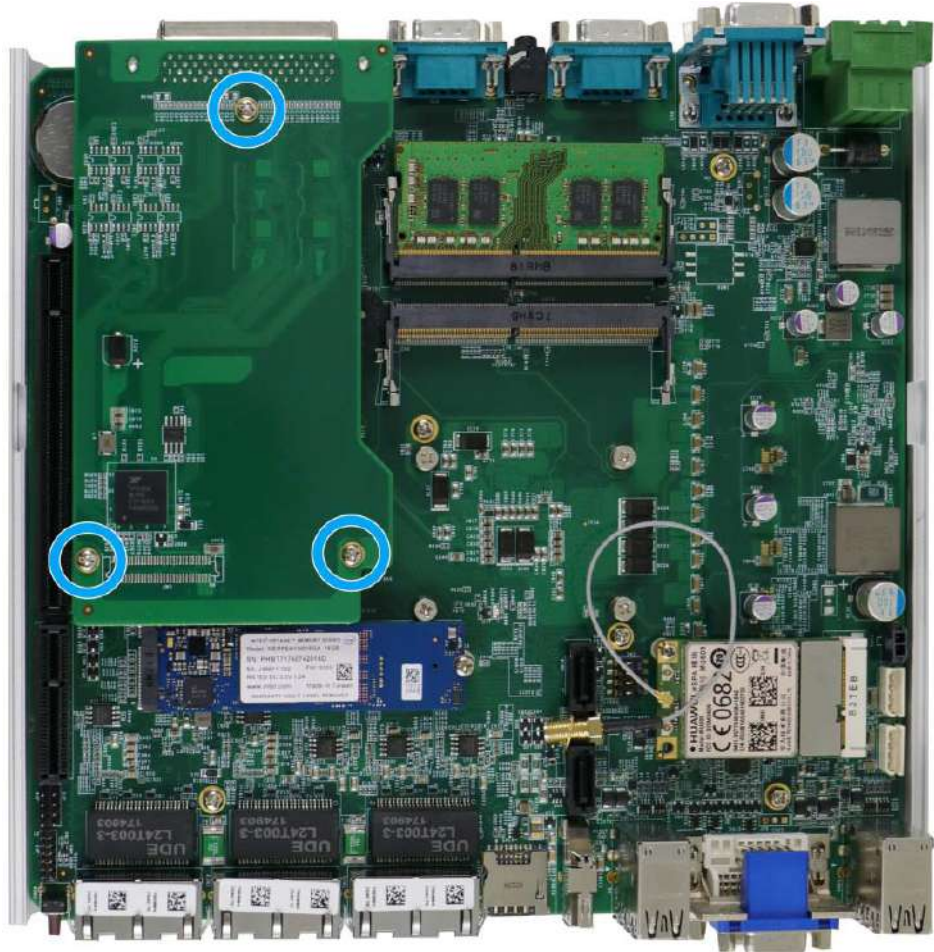

3. Reinstall the system enclosure and panel when done. To reinstall the system enclosure, the bottom panel on top of the motherboard while making sure both sides are inserted into the heatsink (indicated in **blue**).

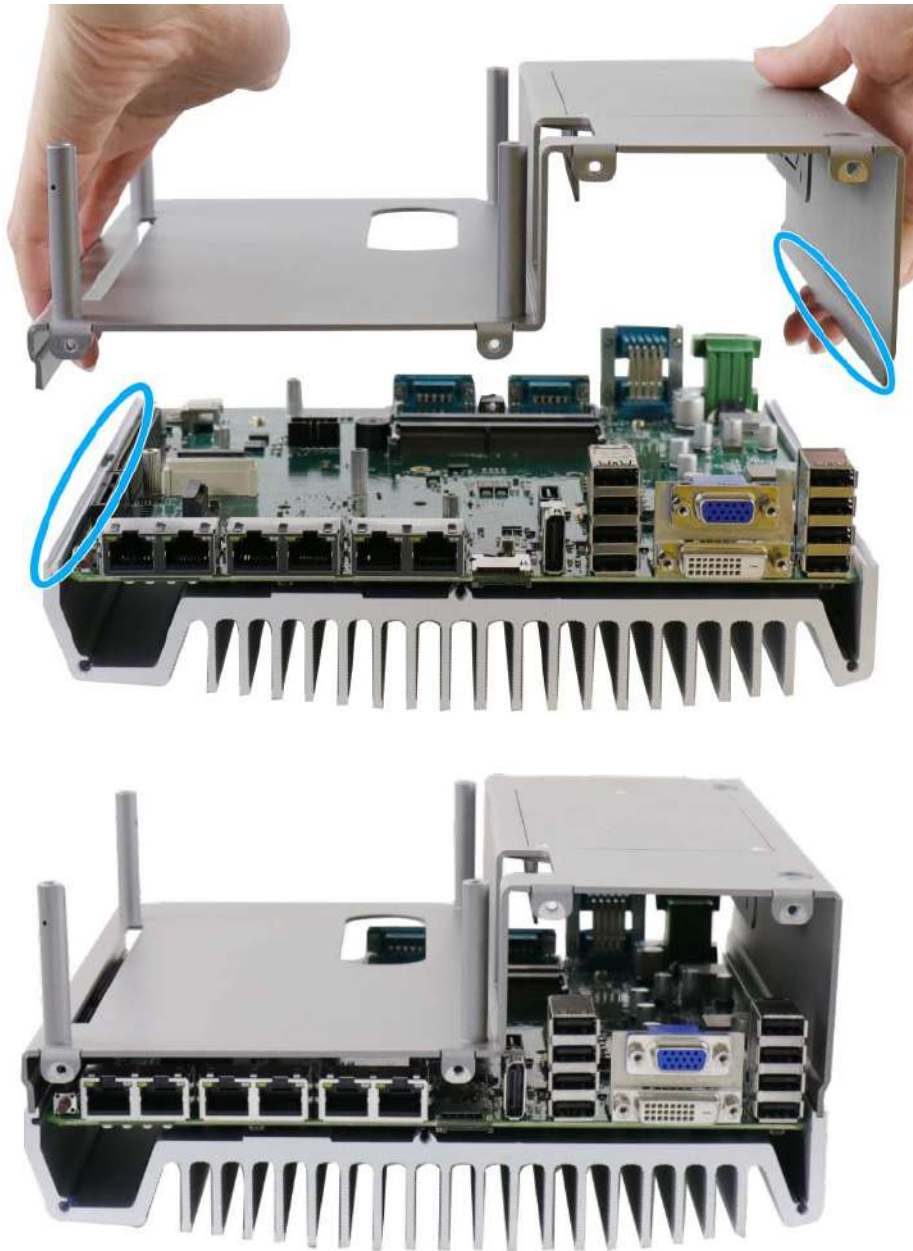

4. Install front/ rear panel and secure screws indicated in **blue**.



Install front panel and secure screws



Install rear panel and secure screws

5. Gently lower the Cassette module onto the system enclosure, press firmly to ensure the PCIe slot is properly engaged.



6. Secure the screws indicated to complete the enclosure installation process.

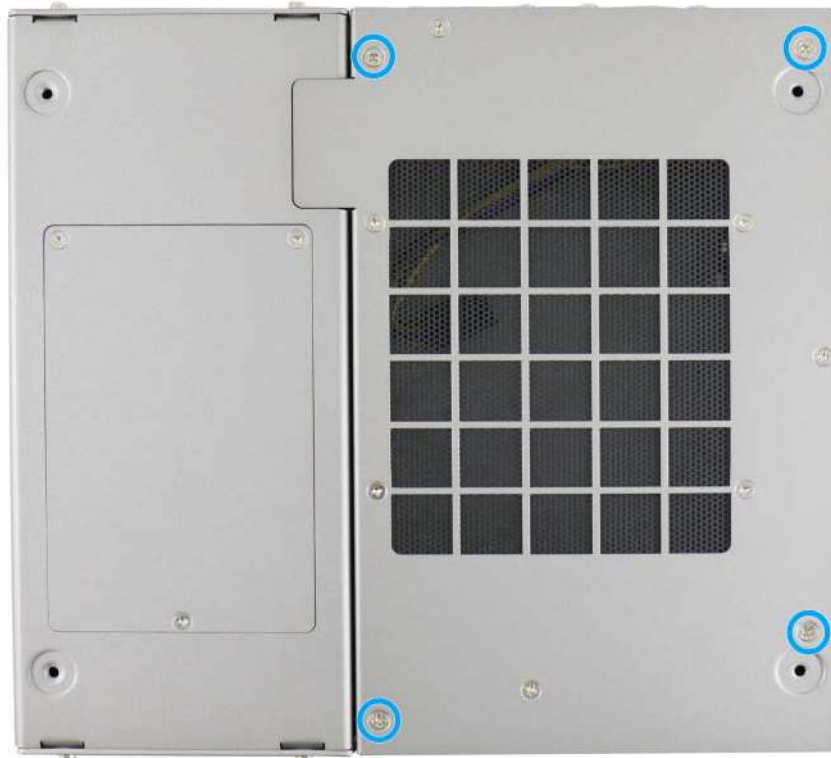

4 Driver Installation

Neosys MezIO™ module provides application-oriented functionality to your Neosys rugged embedded system. Incorporating computer signals, power rails and control signals, the module can further be customized to suit your needs!

For the latest drivers, please go [here](#). You should see a list of MezIO™ modules and corresponding drivers. You may click on [Details](#) and a window should appear with driver details. The window content should show compatible operating system(s), driver file size, when (date) it was released and a download button.

Windows XP/7/8/10 64-bit



Windows XP/7/8/10 64-bit **New**

File Size: 65.49 kB

Date: [2017/03/17]

Download

When downloading a driver, make sure you download the driver that is for your operating system and it matches the MezIO™ module installed.

4.6 MezIO™ C180/ C181 Driver Installation

The MezIO™ C180/ C181 driver is delivered in a compressed package.

To install the driver, please refer to the following steps:

1. Choose your MezIO™ driver version and click [Download](#).
2. Go to the directory where the downloaded file is saved, right-click and choose to “Extract All”.

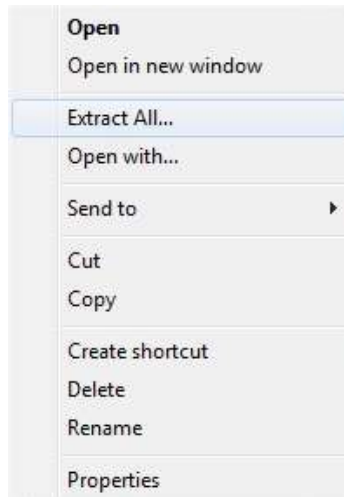

3. Select a directory you wish to save the files to by clicking on “Browse” then click on “Extract” at the bottom right corner.

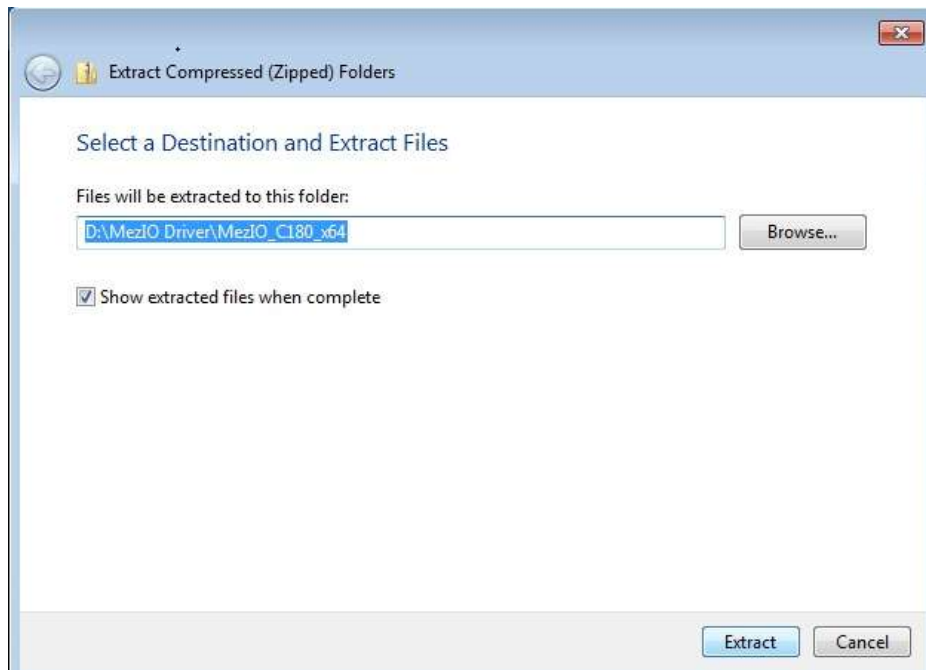

4. Once the files has been extracted to the desired folder, you may begin installing the driver by going to Start > right-click on My Computer > Manage.

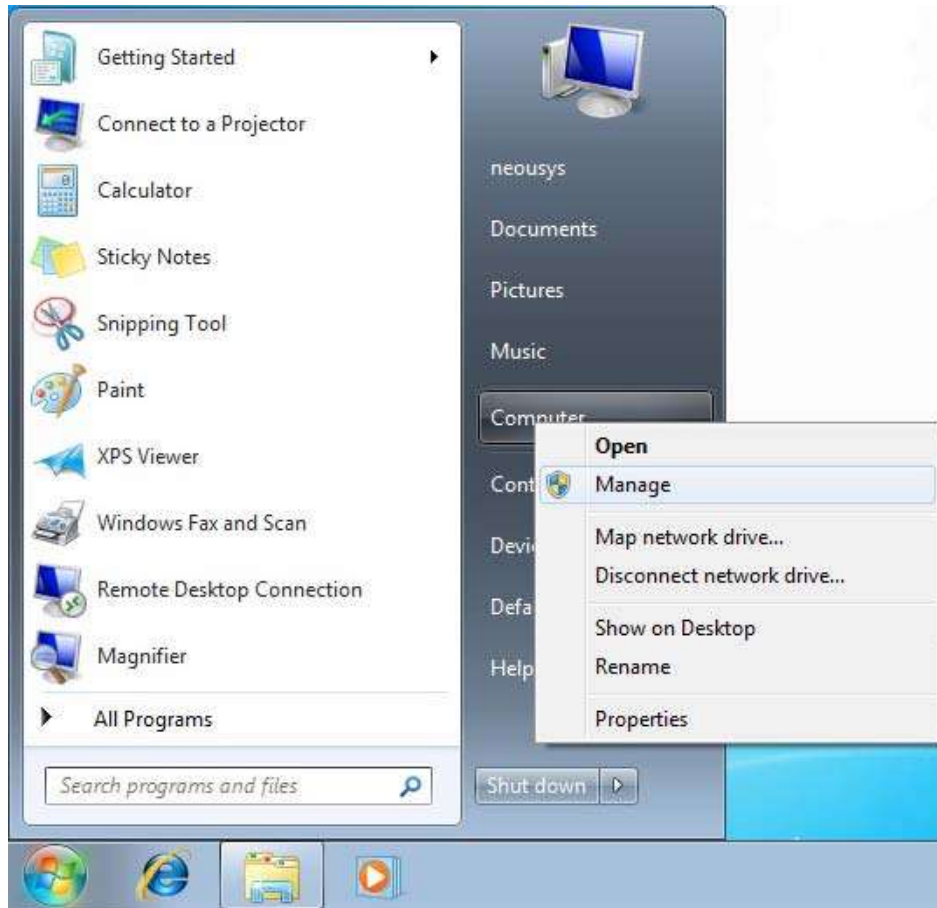

5. Click on device manager and you should see a device without driver (indicated by an exclamation mark).

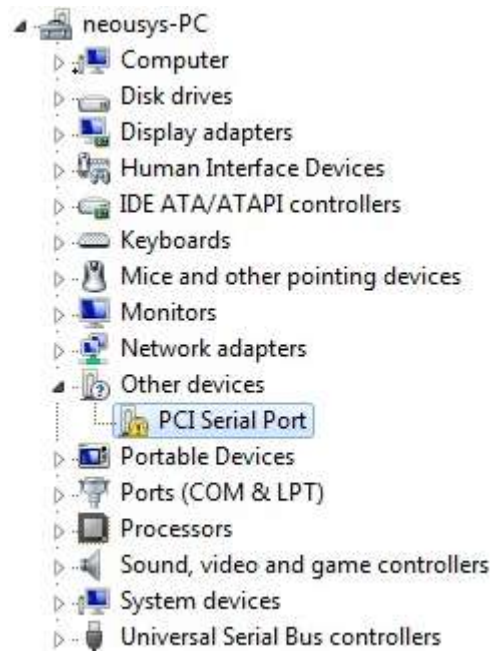

6. Double click on it to bring up the device's properties and click on "Update Driver".



7. Select the option "Browse my computer for driver software".

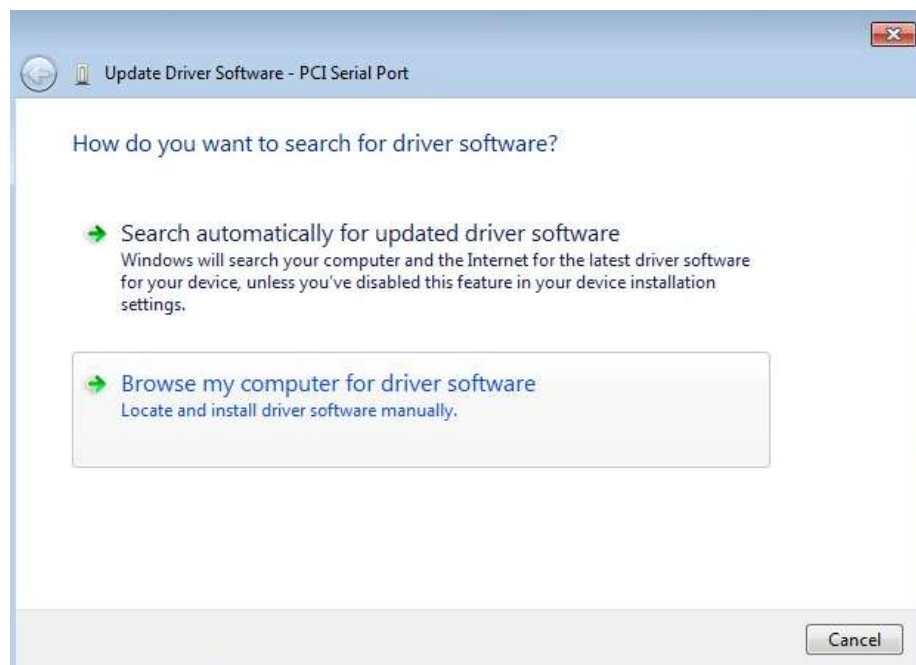

8. Click on "Browse" to point to the directory where the driver files were extracted to and click on Next.



9. A Windows Security prompt will appear. Click on Install to begin the installation process.

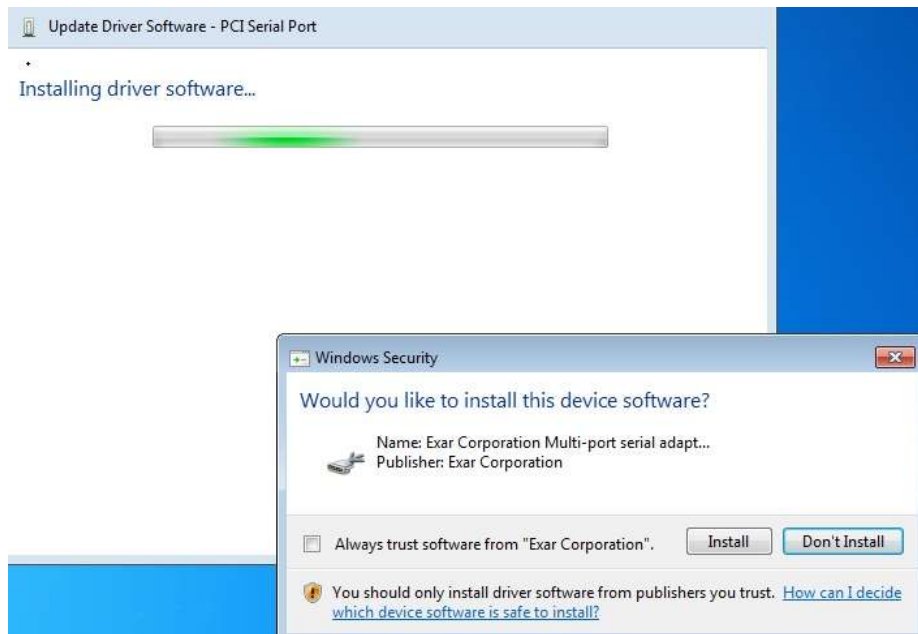

10. The installation process may take up to a few minutes. When completed, the following message should appear.

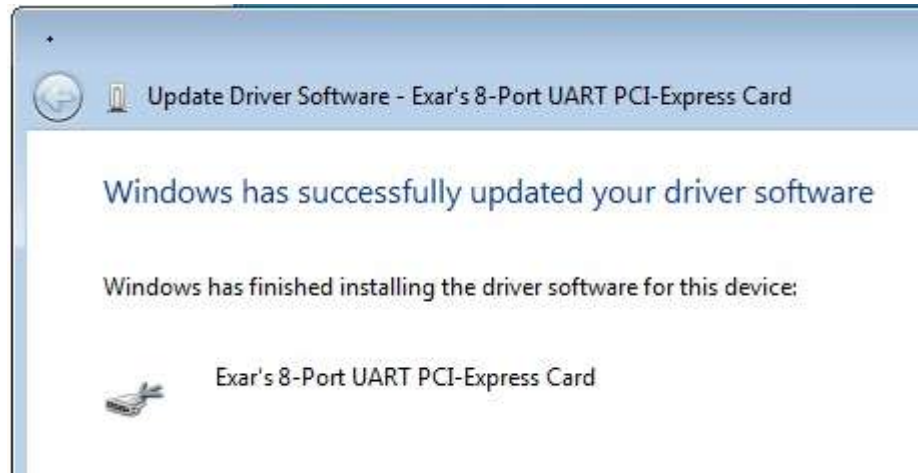

11. At this stage, you should see eight (8) other "Multifunction Device" without driver (indicated by exclamation mark).

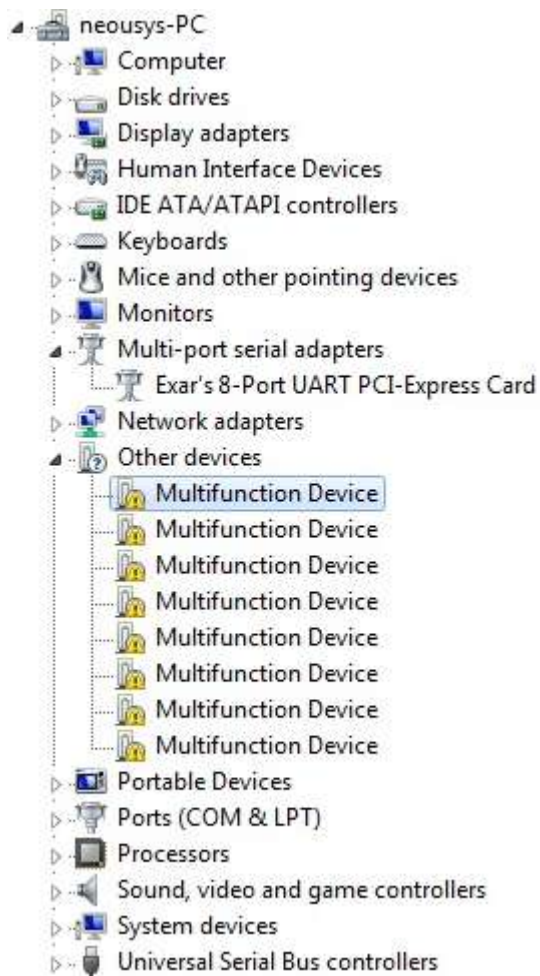

12. Double click on one for device's properties and click on "Update Driver".



13. Select the option "Browse my computer for driver software".



14. Click on "Browse" to point to the directory where the driver files were extracted to and click on Next.



15. A Windows Security prompt will appear. Click on Install to begin the installation process.



16. The installation process may take up to a few minutes. When completed, the following message should appear.

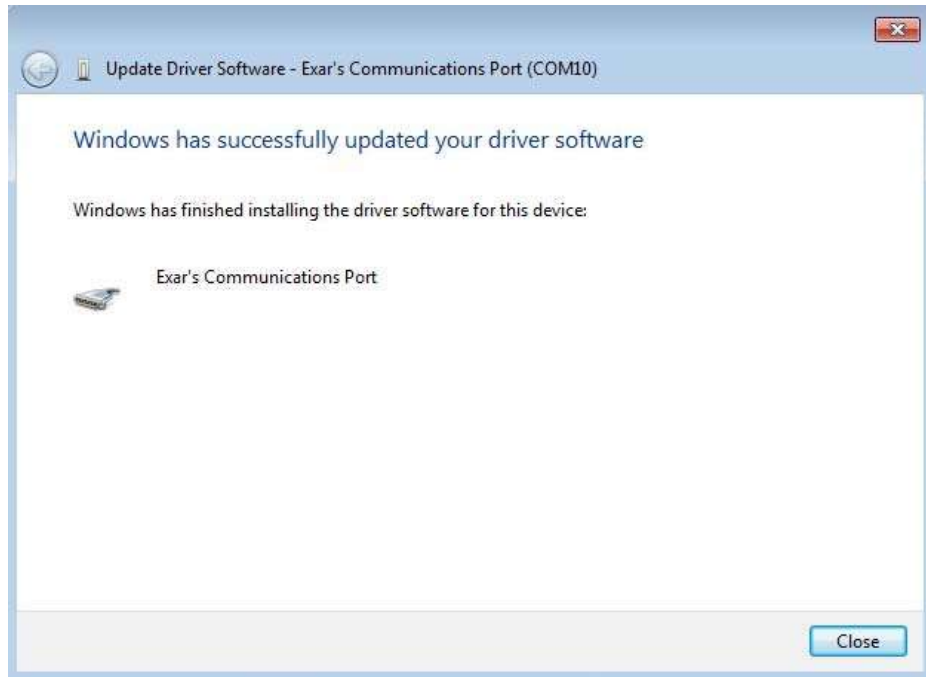

17. Repeat the “Update Driver” procedures (steps 11~16) for the other seven (7) Multifunction Devices until they are all installed.

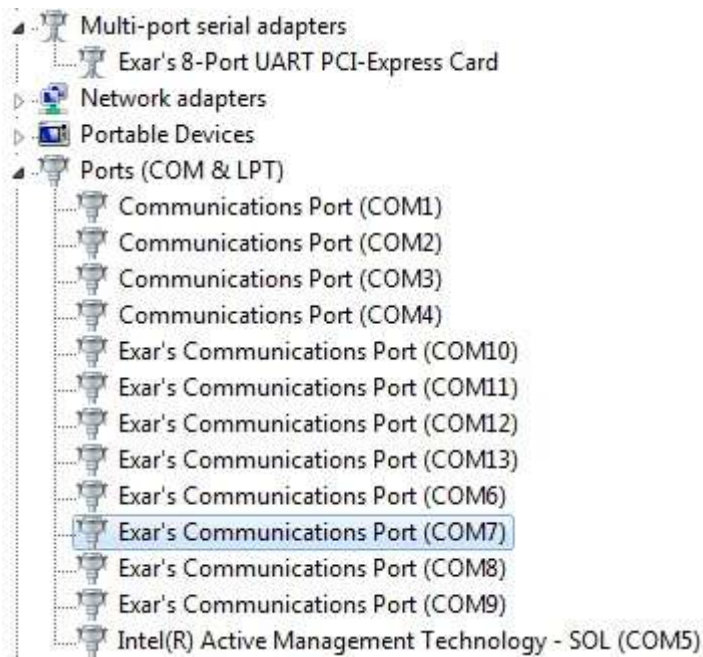

4.7 MezIOTM D220/ D230 Driver Installation

The MezIO™ D230/ D220 driver package is delivered in a compressed package. You must download the package and extract the file in order to install the driver.

Remember the path you extracted to, go to the directory, locate the “auto-execute” (.exe) file and follow the instructions below.

To install the driver, please refer to the following steps:

1. Choose the MezIO™ driver version that matches your operating system and click [Download](#).
2. Go to the directory where the downloaded file is saved, right-click and choose “Extract All” and remember the path where files are extracted to.

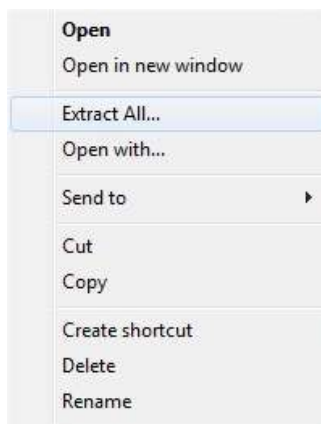

3. Locate the “auto-execute” (.exe) file that was extracted. Right-click on the “.exe” file, choose [Run as administrator](#).

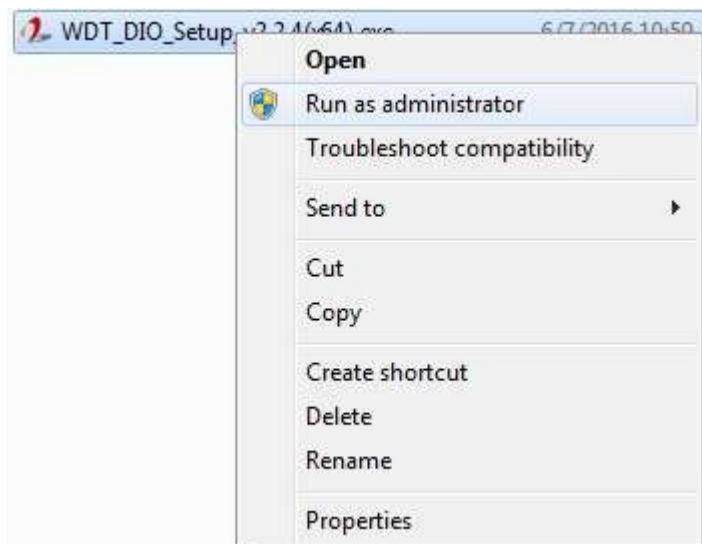

4. The installation screen will show and follow the instructions shown, click on “Next >” when ready.

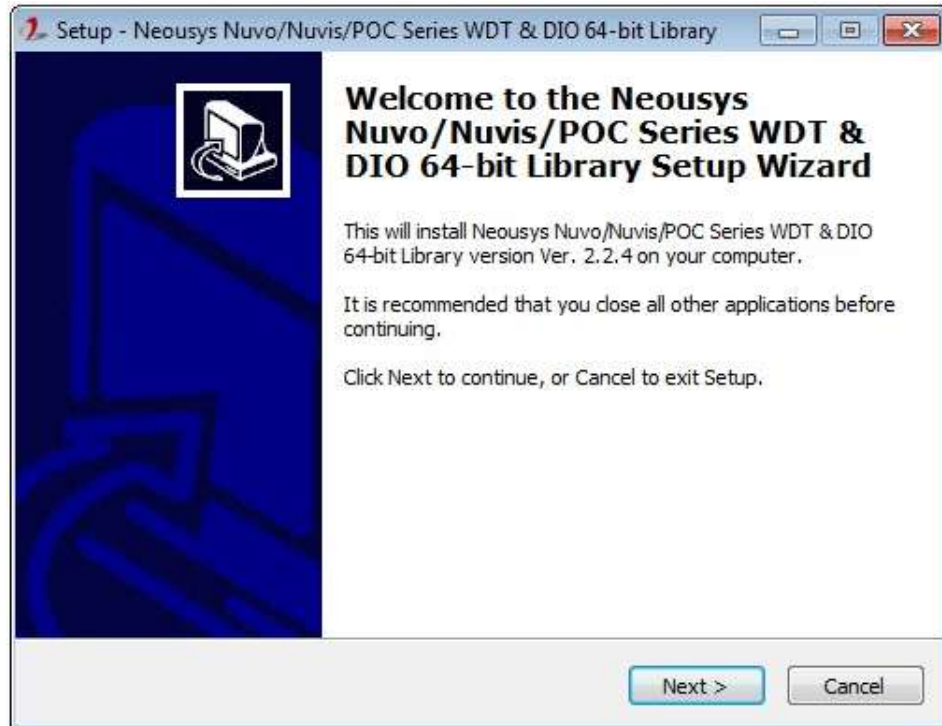

5. Once setup has gathered system hardware information, it is ready to install. Click on "Install" to begin.

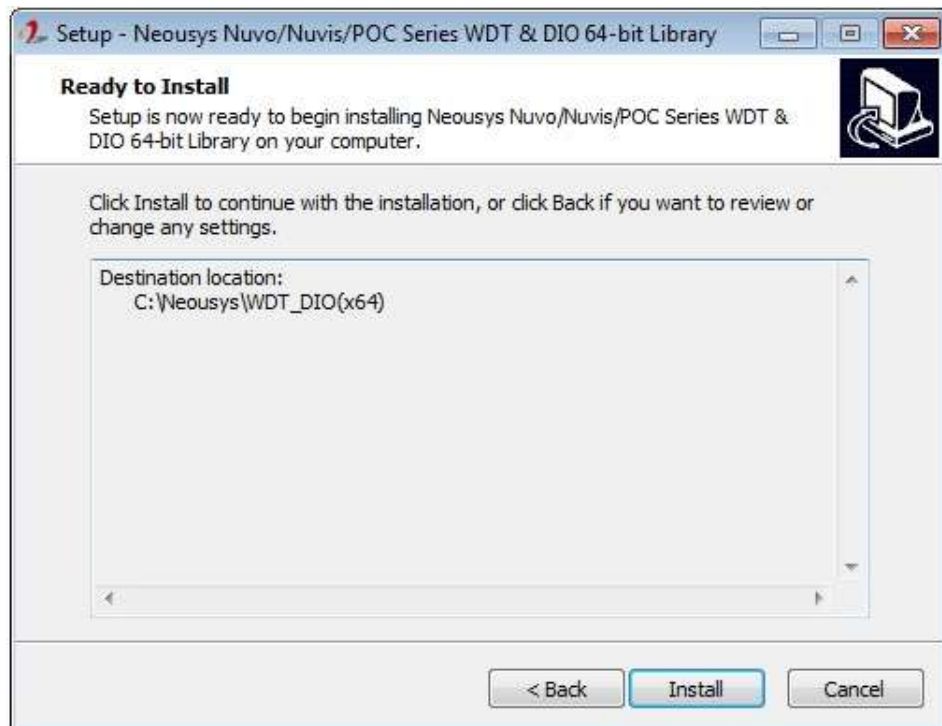

6. Please be patient as the installation process may take up to a few minutes.

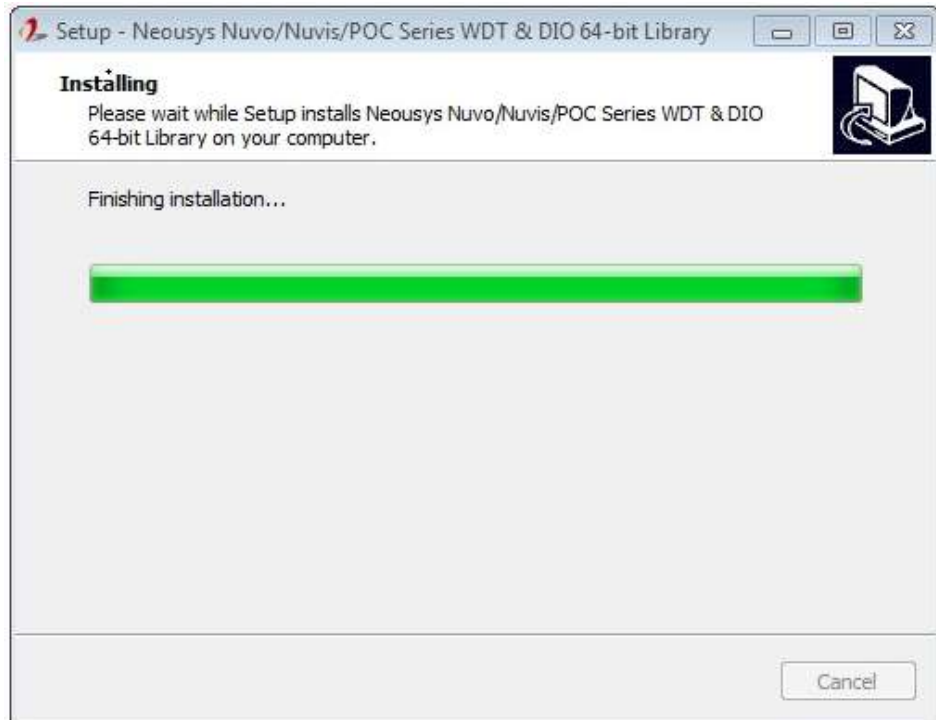

7. When completed, it will prompt you for an immediate system restart or you may choose to restart later. Make your selection and click on "Finish". If you choose to restart immediately, please remember to save and close your work/ tasks before doing so. Failure to do so may result in permanent data loss!

